

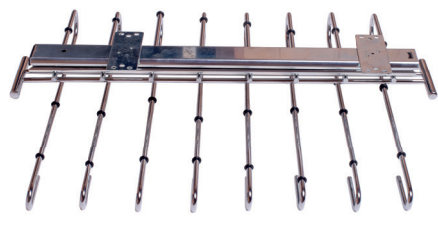



### PANTALONERO EXTRACCIÓN TOTAL IA1



	Código	8431488	Tipo	Acabado				€uros
Caja	94001	940014	8 perchas	CB	-	1	5	
	94002	940021	10 perchas	CB	-	1	5	

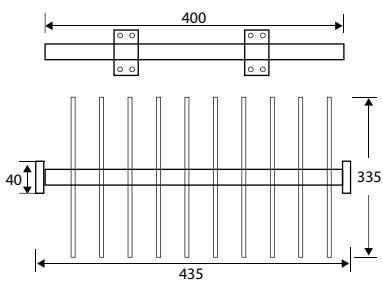

Acero  
  
 CROMO BRILLO

### PANTALONERO EXTRACCIÓN TOTAL IA2

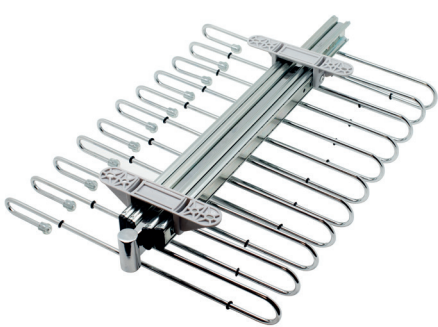

	Código	8431488	Tipo	Acabado				€uros
Caja	94003	940038	11 perchas	CB	-	1	5	

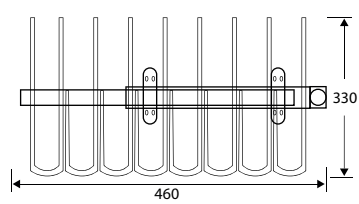

Acero  
  
 CROMO BRILLO



Antideslizante  
 Tope: Goma  
 Tirador: Zamak



### ZAPATERO LATERAL EXTRACCIÓN TOTAL IA3



	Código	8431488	Medida	Acabado				€uros
Caja	94014	940144	400/600x120x450 mm	CB	-	1	2	
	94015	940151	600/1000x120x450 mm	CB	-	1	2	

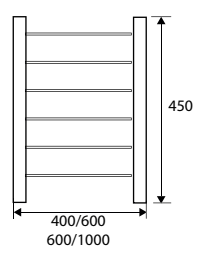

Acero  
  
 CROMO BRILLO

### ZAPATERO FRONTAL CAJÓN EXTRAÍBLE IA4

	Código	8431488	Medida	Acabado				€uros
Caja	94012	940120	400/600x120x400 mm	CB	-	1	2	
	94013	940137	600/1000x120x450 mm	CB	-	1	2	

Acero

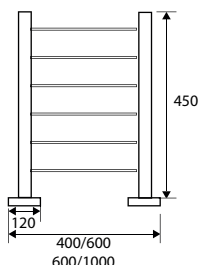

### JGO ZAPATERO IA6

	Código	8431488	Tipo	Acabado				€uros
	94025	940250	2 baldas	BL	-	1	6	
	94026	940267	2 baldas	MA	-	1	6	

Poliestireno



Retractable individual

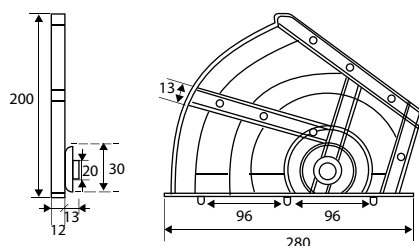

### CORBATERO VARILLA IA8

	Código	8431488	Medida A	Acabado				€uros
Blister	10079	100791	250 mm	OR	1	-	10	
	10080	100807	300 mm	OR	1	-	10	
	10081	100814	350 mm	OR	1	-	10	
	10082	100821	400 mm	OR	1	-	10	
	10083	100838	450 mm	OR	1	-	10	
	10084	100845	500 mm	OR	1	-	10	
	10792	107929	250 mm	NI	1	-	10	
	10802	108025	300 mm	NI	1	-	10	
	10812	108124	350 mm	NI	1	-	10	
	10822	108223	400 mm	NI	1	-	10	
	10832	108322	450 mm	NI	1	-	10	
	10842	108421	500 mm	NI	1	-	10	

Acero

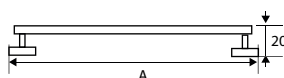
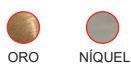



### SOPORTE PERCHAS EXTRAÍBLE IA7



Código	8431488	Medida A	Acabado				€uros
94018	940182	300 mm	CB	-	1	20	
94019	940199	350 mm	CB	-	1	20	
94020	940205	400 mm	CB	-	1	20	
94021	940212	450 mm	CB	-	1	20	
94023	940236	500 mm	CB	-	1	20	

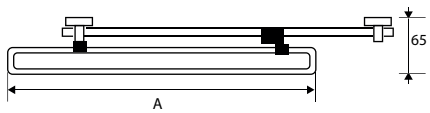

Acero  
 CROMO BRILLO



### PERCHERO ABATIBLE IA5

Código	8431488	Medida A	Acabado				€uros
94009	940090	450/600 mm	AL	-	1	6	
94010	940106	600/830 mm	AL	-	1	6	
94011	940113	830/1150 mm	AL	-	1	6	

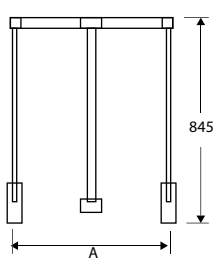

Aluminio  
 ALUMINIO

### ESPIRAL DE VISILLO FORRADO EV1

Código	8431488	Medida	Acabado				€uros
Caja	73328	733289	50 mts	-	1	10	
Blister	91801	918013	2 mts	1	-	10	
	91228	912288	3 mts	1	-	10	

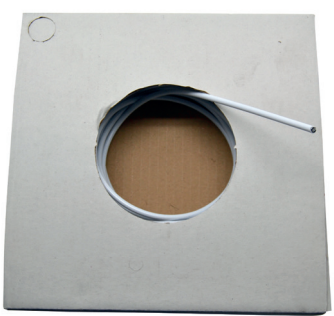

91228 - 4 hembrillas abiertas y 4 hembrillas cerradas

91801 - 2 hembrillas abiertas y 2 hembrillas cerradas

Acero  
 BLANCO

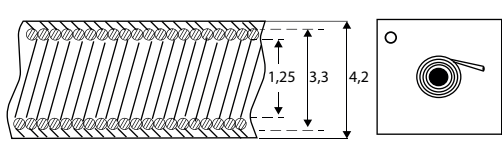

### TERMINAL ESPIRAL VISILLO EV2

	Código	8431488	Medida	Acabado			€uros
Caja	<b>73335</b>	733357	8x5 mm	NI	-	50 200	

Latón

No incluye hembra

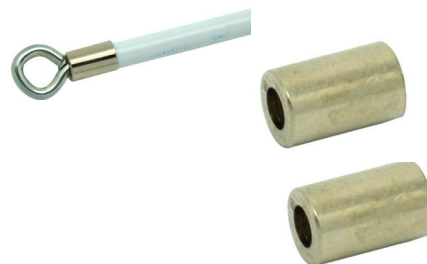

### KIT TERMINAL ESPIRAL VISILLO EV3

	Código	8431488	Medida	Acabado			€uros
Caja	<b>91379</b>	913797	-	NI	-	50 500	
Blistar	<b>91380</b>	913803	-	NI	1	- 10	

Acero/Latón

Contiene 2 Hembra abiertas, 2 Hembra cerradas y 2 terminales

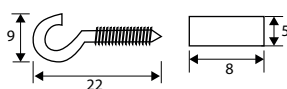

### LED C/SENSOR MULTIUSO LD2

	Código	8431488	Medida	Acabado			€uros
Caja	<b>92002</b>	920023	65x60 mm	BL	-	1 20	
Blistar	<b>92426</b>	924267	65x60 mm	BL	1	- 10	

Polipropileno

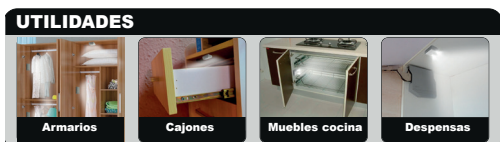
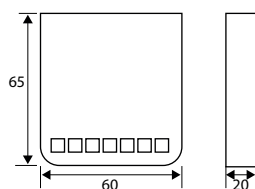

Lámpara de inducción.  
Fácil instalación  
Muy útil, ilumina al abrirse: cajones, despensas, armarios, muebles de cocina, etc.  
Funciona a pilas (incluidas)

### TUBO ARMARIO C/LED LD1

	Código	8431488	Medida	Acabado			€uros
Caja	<b>92001</b>	920016	30x15 mm x 1 mt	PL	-	1 5	

Aluminio

Con sensor  
0,6 W  
9v. DC

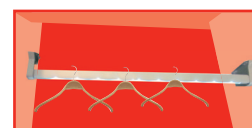

Activación mediante sensor de movimiento a una distancia de 1,5 - 2 mts, y se apaga transcurridos 20 segundos. Funcionamiento a pilas, con fácil sustitución. Último tramo con corte para su perfecta adaptación. Incorpora una goma para evitar arañazos de las perchas.



## TUBO ARMARIO TA1



	Código	8431488	Medida AxB	Acabado			€uros
Caja	12100	121000	ø12 mm x 1 mt	CB	-	25	-
	12150	121505	ø12 mm x 1,5 mts	CB	-	25	-
	12200	122007	ø12 mm x 2 mts	CB	-	25	-
	12250	122502	ø12 mm x 2,5 mts	CB	-	25	-
	12300	123004	ø12 mm x 3 mts	CB	-	25	-
	12400	124001	ø12 mm x 4 mts	CB	-	25	-
	12401	124018	ø12 mm x 4 mts	BL	-	25	-
	16100	161006	ø16 mm x 1 mt	CB	-	25	-
	16150	161501	ø16 mm x 1,5 mts	CB	-	25	-
	16200	162003	ø16 mm x 2 mts	CB	-	25	-
	16250	162508	ø16 mm x 2,5 mts	CB	-	25	-
	16300	163000	ø16 mm x 3 mts	CB	-	25	-
	16400	164007	ø16 mm x 4 mts	CB	-	25	-
	16401	164014	ø16 mm x 4 mts	BL	-	25	-
	19100	191003	ø19 mm x 1 mt	CB	-	20	-
	19150	191508	ø19 mm x 1,5 mts	CB	-	20	-
	19200	192000	ø19 mm x 2 mts	CB	-	20	-
	19250	192505	ø19 mm x 2,5 mts	CB	-	20	-
	19300	193007	ø19 mm x 3 mts	CB	-	20	-
	19400	194004	ø19 mm x 4 mts	CB	-	20	-
	20400	204000	ø25 mm x 4 mts	CB	-	10	-



Precio por tubo  
Espesor 0,8 mm

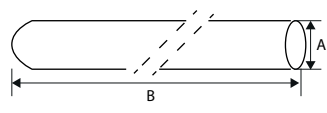

Acero  
 CROMO BRILLO  
 BLANCO

## EMPALME TUBO TA5

	Código	8431488	Medida	Acabado			€uros
Caja	73327	733272	ø12 mm	ZN	-	25	250
Blister	91230	912301	ø12 mm	ZN	2	-	10

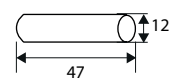

Acero  
 ZINCADO

## TUBO ARMARIO OVAL TA2



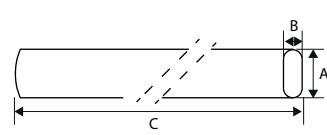

	Código	8431488	Medida AxBxC	Acabado			€uros
Caja	25200	252001	25x15 mm x 2 mts	CB	-	20	-
	25400	254005	25x15 mm x 4 mts	CB	-	20	-
	25403	254036	30x15 mm x 4 mts	CB	-	15	-
	25201	252018	25x15 mm x 2 mts	LTD	-	20	-
	25401	254012	25x15 mm x 4 mts	LTD	-	20	-
	25402	254029	25x15 mm x 4 mts	BL	-	20	-

Precio por tubo  
Espesor 0,8 mm



Acero  
 CROMO BRILLO  
 LATONADO  
 BLANCO

### TUBO ARMARIO RETRACTILADO TA3

Código	8431488	Medida AxB	Acabado				€uros
30404	304045	ø19 mm x 1 mts	CB	-	20	-	
30395	303956	ø19 mm x 1,5 mts	CB	-	20	-	
30405	304052	ø19 mm x 2 mts	CB	-	20	-	
30406	304069	25x15 mm x 1 mts	CB	-	20	-	
30394	303949	25x15 mm x 1,5 mts	CB	-	20	-	
30407	304076	25x15 mm x 2 mts	CB	-	20	-	
30396	303963	25x15 mm x 2,5 mts	CB	-	20	-	
30408	304083	25x15 mm x 1 mts	LTD	-	20	-	
30386	303864	25x15 mm x 1,5 mts	LTD	-	20	-	
30409	304090	25x15 mm x 2 mts	LTD	-	20	-	
30390	303901	30x15 mm x 1 mts	CB	-	15	-	
30391	303918	30x15 mm x 2 mts	CB	-	15	-	



Acero

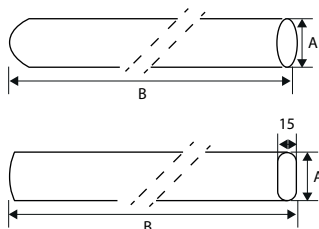

Precio por tubo  
Espesor 0,8 mm  
Retractilado individualmente



### TUBO ARMARIO OVAL TA4

Código	8431488	Medida AxBxC	Acabado				€uros
30387	303871	30x15 mm x 2 mts	PL	-	10	-	
30400	304007	30x15 mm x 4 mts	PL	-	10	-	
30388	303888	30x15 mm x 2 mts	OR	-	10	-	
30401	304014	30x15 mm x 4 mts	OR	-	10	-	



Aluminio



Precio por tubo  
Espesor 1,2 mm



### TUBO ARMARIO ESQUINERO OVAL TA6

Código	8431488	Medida AxB	Acabado				€uros
30384	303840	30x1 mt	PL	-	10	-	
30385	303857	30x1 mt	OR	-	10	-	

Aluminio

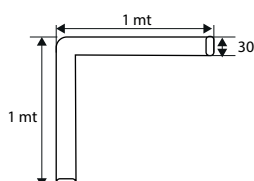



### SOPORTE LATERAL REDONDO STA1

	Código	8431488	Medida A	Acabado				€uros
Caja	70121	701219	12 mm	NI	-	100	1000	
	70161	701615	16 mm	NI	-	100	1000	
	70191	701912	19 mm	NI	-	100	500	
Blister	90238	902388	12 mm	NI	2	-	10	
	90237	902371	16 mm	NI	2	-	10	
	90236	902364	19 mm	NI	2	-	10	

Incluye tornillos en el blister

Latón

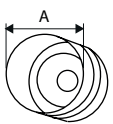

NIQUEL



### SOPORTE CENTRAL REDONDO STA2

	Código	8431488	Medida A	Acabado				€uros
Caja	71121	711218	12 mm	NI	-	50	250	
	71161	711614	16 mm	NI	-	50	250	
	71191	711911	19 mm	NI	-	50	250	
Blister	90254	902548	12 mm	NI	2	-	10	
	90255	902555	16 mm	NI	2	-	10	
	90256	902562	19 mm	NI	2	-	10	

Incluye tornillos en el blister

Zamak

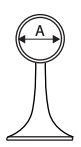

NIQUEL



### SOPORTE LATERAL STA1 + CENTRAL STA2

	Código	8431488	Medida A	Acabado				€uros
Blister	90241	902418	12 mm	NI	2+1	-	10	
	90240	902401	16 mm	NI	2+1	-	10	
	90239	902395	19 mm	NI	2+1	-	10	

Incluye tornillos en el blister

Latón/Zamak

Contiene 2 casquillos y 1 soporte central

NIQUEL

### SOPORTE CERRADO REDONDO STA3

	Código	8431488	Medida A	Acabado				€uros
Caja	72121	721217	12 mm	NI	-	50	250	
	72161	721613	16 mm	NI	-	50	250	
	72191	721910	19 mm	NI	-	50	250	
Blister	90257	902579	12 mm	NI	2	-	10	
	90258	902586	16 mm	NI	2	-	10	
	90259	902593	19 mm	NI	2	-	10	

Incluye tornillos en el blister

Zamak

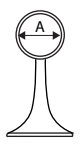

NIQUEL





### SOPORTE LATERAL REDONDO STA4

	Código	8431488	Medida A	Acabado				€uros
Caja	70251	702513	25 mm	CB	-	50	500	

Acero

CROMO BRILLO

Incluye tornillos en el blíster

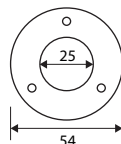

### SOPORTE CENTRAL REGULABLE STA5

	Código	8431488	Medida	Acabado				€uros
Caja	71251	712512	25 mm	NI	-	50	250	

Zamak

NÍQUEL

Incluye tornillos en el blíster  
Regulación de 80 a 100 mm

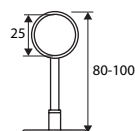

### SOPORTE LATERAL STOR STA14

	Código	8431488	Medida	Acabado				€uros
Caja	75255	752556	14 mm	BC	-	100	1000	
	75256	752563	18 mm	BC	-	100	1000	
	75257	752570	22 mm	BC	-	100	1000	
Blister	91231	912318	14 mm	BC	2	-	10	
	91232	912325	18 mm	BC	2	-	10	
	91233	912332	22 mm	BC	2	-	10	

Acero

BICROMATADO

Incluye tornillos en el blíster

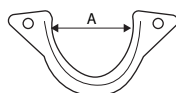

### SOPORTE LATERAL OVAL STA15

	Código	8431488	Medida	Acabado				€uros
Caja	60801	608013	17 mm	BL	-	100	2000	
	60802	608020	17 mm	MA	-	100	2000	
Blister	90247	902470	17 mm	BL	2	-	10	
	90248	902487	17 mm	MA	2	-	10	

Polietileno

BLANCO MARRÓN

Incluye tornillos en el blíster

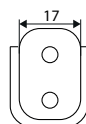



### SOPORTE LATERAL OVAL STA6

	Código	8431488	Medida	Acabado				€uros
Caja	75251	752518	15 mm	NI	-	100	1000	
	75252	752525	15 mm	LTD	-	100	1000	
	75253	752532	15 mm	AL	-	100	1000	
	75254	752549	15 mm	BL	-	100	1000	
Blister	90242	902425	15 mm	NI	2	-	10	
	90243	902432	15 mm	LTD	2	-	10	
	90244	902449	15 mm	AL	2	-	10	
	91229	912295	15 mm	BL	2	-	10	

Incluye tornillos en el blister

Zamak

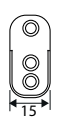

### SOPORTE CENTRAL OVAL STA7

	Código	8431488	Medida Ax B	Acabado				€uros
Caja	73251	732510	25x15 mm	NI	-	50	250	
	73252	732527	25x15 mm	LTD	-	50	250	
Blister	90260	902609	25x15 mm	NI	2	-	10	
	90261	902616	25x15 mm	LTD	2	-	10	

Incluye tornillos en el blister

Zamak

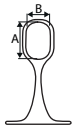

### SOPORTE CENTRAL OVAL STA8

	Código	8431488	Medida Ax B	Acabado				€uros
Caja	73301	733012	30x15 mm	NI	-	50	500	
	73302	733029	30x15 mm	LTD	-	50	500	
	73303	733036	30x15 mm	AL	-	50	500	
Blister	90262	902623	30x15 mm	NI	2	-	10	
	90263	902630	30x15 mm	LTD	2	-	10	
	90264	902647	30x15 mm	AL	2	-	10	

Incluye tornillos en el blister

Zamak

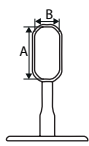

### SOPORTE LATERAL STA6 + CENTRAL OVAL STA7/8

	Código	8431488	Medida interior	Acabado				€uros
Blister	90249	902494	25x15 mm	NI	2+1	-	10	
	90250	902500	25x15 mm	LTD	2+1	-	10	
	90251	902517	30x15 mm	NI	2+1	-	10	
	90252	902524	30x15 mm	LTD	2+1	-	10	
	90253	902531	30x15 mm	AL	2+1	-	10	

Incluye tornillos en el blister  
 Contiene 2 soportes laterales y 1 soporte central

Zamak



### SOPORTE CERRADO OVAL STA9

	Código	8431488	Medida AxB	Acabado				€uros
Caja	74251	742519	25x15 mm	NI	-	50	250	
	74301	743011	30x15 mm	NI	-	50	250	
	74303	743035	30x15 mm	AL	-	50	250	
Blister	90265	902654	25x15 mm	NI	2	-	10	
	90266	902661	30x15 mm	NI	2	-	10	
	92233	922331	30x15 mm	AL	2	-	10	

Zamak



Incluye tornillos en el blister

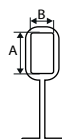

### SOPORTE CENTRAL OVAL REGULABLE STA10

	Código	8431488	Medida AxB	Acabado				€uros
Caja	73304	733043	30x15 mm	CB	-	25	125	
	73305	733050	30x15 mm	LTD	-	25	125	
	73306	733067	30x15 mm	AL	-	25	125	
Blister	90269	902692	30x15 mm	CB	2	-	10	
	90270	902708	30x15 mm	LTD	2	-	10	
	90638	906386	30x15 mm	AL	2	-	10	

Zamak



Incluye tornillos en el blister  
Regulación de 90 a 125 mm

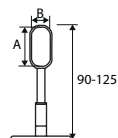

### SOPORTE CERRADO OVAL REGULABLE STA11

	Código	8431488	Medida AxB	Acabado				€uros
Caja	74304	743042	30x15 mm	CB	-	25	125	
	74305	743059	30x15 mm	LTD	-	25	125	
	74306	743066	30x15 mm	AL	-	25	125	
Blister	90639	906393	30x15 mm	CB	2	-	10	
	90640	906409	30x15 mm	LTD	2	-	10	
	90641	906416	30x15 mm	AL	2	-	10	

Zamak



Incluye tornillos en el blister  
Regulación de 90 a 125 mm

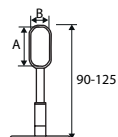



### SOPORTE CERRADO TECHO OVAL STA12



	Código	8431488	Medida	Acabado				€uros
Caja	<b>73324</b>	733241	30x15 mm	AL	-	25	125	

No incluye tornillo

Zamak

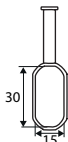

Tornillo Komby disponible en página 281



### SOPORTE ESQUINA TECHO OVAL STA13



	Código	8431488	Medida	Acabado				€uros
Caja	<b>73325</b>	733258	30x15 mm	AL	-	25	125	

No incluye tornillo

Zamak

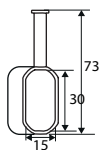

Tornillo Komby disponible en página 281



### SOPORTE LATERAL N° 7 STA20



	Código	8431488	Medida	Acabado				€uros
Caja	<b>73307</b>	733074	12 mm	ZN	-	25	500	

Para tubo de 12 mm

Acero

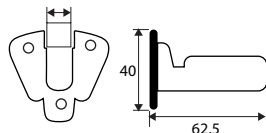

### SOPORTE TECHO N° 2 STA17



	Código	8431488	Medida	Acabado				€uros
Caja	<b>73308</b>	733081	12 mm	ZN	-	25	500	
	<b>73316</b>	733166	12 mm	BL	-	25	500	

Para tubo de 12 mm

Acero

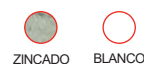
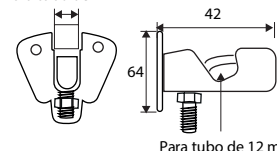

**SOPORTE FRENTE N° 1 STA16**

	Código	8431488	Medida A	Acabado			€uros
Caja	<b>73309</b>	733098	12 mm	ZN	-	25	250
	<b>73315</b>	733159	12 mm	BL	-	25	250
	<b>73326</b>	733265	16 mm	ZN	-	25	250

Acero

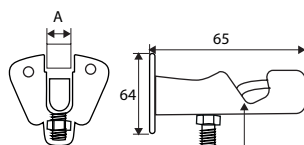

73309: Para tubo de 12 mm  
73315: Para tubo de 12 mm  
73326: Para tubo de 16 mm



**SOPORTE EXTENSIBLE N° 4 STA18**

	Código	8431488	Medida	Acabado			€uros
Caja	<b>73310</b>	733104	12 mm	ZN	-	25	250
	<b>73317</b>	733173	12 mm	BL	-	25	250

Acero

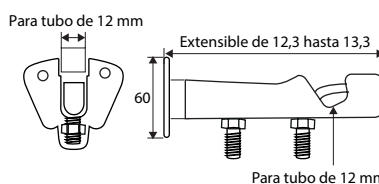

**SOPORTE EXTENSIBLE DOBLE N° 5 STA19**

	Código	8431488	Medida	Acabado			€uros
Caja	<b>73311</b>	733111	12 mm	ZN	-	25	250

Acero

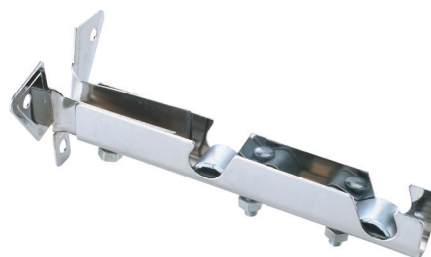
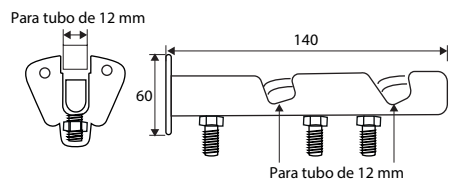

**SOPORTE DOBLE TECHO N° 9 STA21**

	Código	8431488	Medida	Acabado			€uros
Caja	<b>73312</b>	733128	12 mm	ZN	-	25	250

Acero

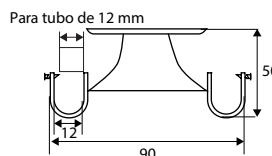

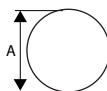
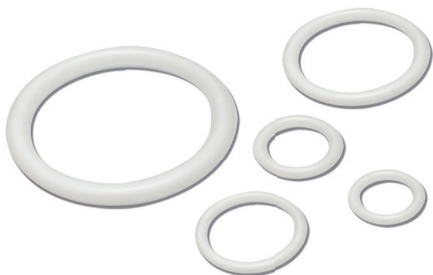
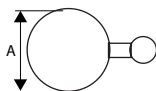
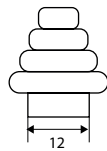

Nylon

## REMATE TUBO BELLOTA CT1

	Código	8431488	Medida	Acabado				€uros
Caja	73313	733135	12 mm	CB	-	100	1000	
	73318	733180	12 mm	BL	-	100	1000	
Blister	90849	908496	12 mm	CB	2	-	10	
	91234	912349	12 mm	BL	2	-	10	

CB: ABS - BL: Poliestireno



## REMATE TUBO PIÑA CT2

	Código	8431488	Medida A	Acabado				€uros
Caja	73331	733319	12 mm	CB	-	100	1000	
	73332	733326	12 mm	BL	-	100	1000	
	73333	733333	16 mm	CB	-	50	1000	
	73334	733340	16 mm	BL	-	50	1000	
Blister	91238	912387	12 mm	CB	2	-	10	
	91239	912394	12 mm	BL	2	-	10	
	91240	912400	16 mm	CB	2	-	10	
	91241	912417	16 mm	BL	2	-	10	

CB: ABS - BL: Poliestireno



## ANILLA TUBO CT3

	Código	8431488	Medida A	Acabado				€uros
Caja	73314	733142	12 mm	CB	-	100	2000	
	73319	733197	12 mm	BL	-	100	2000	
	73329	733296	16 mm	CB	-	50	1000	
	73330	733302	16 mm	BL	-	50	1000	
Blister	90848	908489	12 mm	CB	6	-	10	
	91235	912356	12 mm	BL	6	-	10	
	91237	912370	16 mm	CB	6	-	10	
	91236	912363	16 mm	BL	6	-	10	

CB: ABS - BL: Poliestireno



## ANILLA REDONDA CT17

	Código	8431488	Medida A	Acabado				€uros
Caja	73349	733494	8 mm	BL	-	100	-	
	73350	733500	10 mm	BL	-	100	-	
	73351	733517	13 mm	BL	-	100	-	
	73352	733524	16 mm	BL	-	100	-	
	73353	733531	18 mm	BL	-	100	-	
	73354	733548	20 mm	BL	-	100	-	
	73355	733555	22 mm	BL	-	100	-	
	73356	733562	25 mm	BL	-	100	-	
	73357	733579	30 mm	BL	-	100	-	
Blister	92174	921747	8 mm	BL	25	-	10	
	92175	921754	10 mm	BL	25	-	10	
	92176	921761	13 mm	BL	25	-	10	
	92177	921778	16 mm	BL	25	-	10	
	92178	921785	18 mm	BL	25	-	10	
	92179	921792	20 mm	BL	20	-	10	
	92180	921808	22 mm	BL	20	-	10	
	92181	921815	25 mm	BL	15	-	10	
	92182	921822	30 mm	BL	10	-	10	

BLANCO

### GARFIO CORTINA FRENTE CT7

	Código	8431488	Medida	Acabado				€uros
Caja	<b>73336</b>	733364	82x15 mm	ZN	-	100	1000	
Blister	<b>92121</b>	921211	82x15 mm	ZN	6	-	10	

Acero



ZINCADO

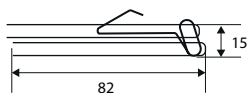

### GARFIO CORTINA TECHO CT8

	Código	8431488	Medida	Acabado				€uros
Caja	<b>73337</b>	733371	82x15 mm	ZN	-	100	1000	
Blister	<b>92122</b>	921228	82x15 mm	ZN	6	-	10	

Acero



ZINCADO

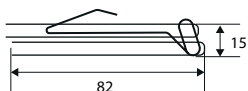

### CORCHETE CORTINA CT9

	Código	8431488	Medida	Acabado				€uros
Caja	<b>73338</b>	733388	28,6x11,8 mm	ZN	-	200	5000	
Blister	<b>92123</b>	921235	28,6x11,8 mm	ZN	25	-	10	

Acero



ZINCADO

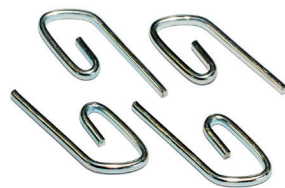
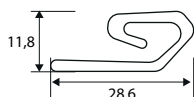

### CORCHETE CORTINA CT5

	Código	8431488	Medida	Acabado				€uros
Caja	<b>73322</b>	733227	28,6x11,8 mm	BL	-	200	5000	
Blister	<b>91388</b>	913889	28,6x11,8 mm	BL	25	-	10	

Polietileno



BLANCO

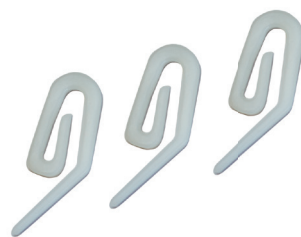
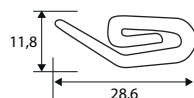

### CORCHETE CORTINA COSER CT12

	Código	8431488	Medida	Acabado				€uros
Caja	<b>73339</b>	733395	24,5x16,25 mm	BL	-	200	2000	
Blister	<b>92124</b>	921242	24,5x16,25 mm	BL	25	-	10	

Nylon



BLANCO

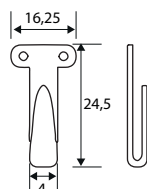



### CORCHETE CORTINA COSER CT11



	Código	8431488	Medida	Acabado				€uros
Caja	<b>73340</b>	733401	42,6x14,25 mm	ZN	-	200	5000	
Blister	<b>92125</b>	921259	42,6x14,25 mm	ZN	25	-	10	

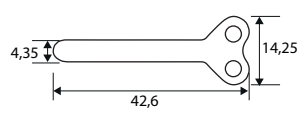

Acero  
 ZINCADO

### GANCHO CORTINA CT6



	Código	8431488	Medida	Acabado				€uros
Caja	<b>73320</b>	733203	pequeño	ZN	-	200	2000	
	<b>73321</b>	733210	grande	ZN	-	200	2000	

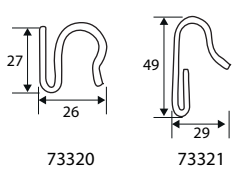

Acero  
 ZINCADO

### ALFILER VISILLO CT13

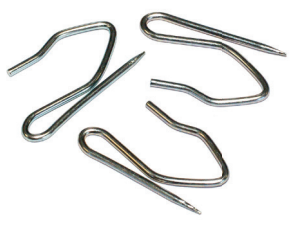

	Código	8431488	Medida	Acabado				€uros
Caja	<b>73342</b>	733425	35x19 mm	ZN	-	200	2000	
Blister	<b>92127</b>	921273	35x19 mm	ZN	25	-	10	

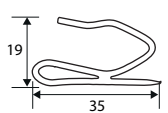

Acero  
 ZINCADO

### CORCHETE GUÍA RIEL CT10



	Código	8431488	Medida	Acabado				€uros
Caja	<b>73341</b>	733418	11 mm	BL	-	200	2000	
Blister	<b>92126</b>	921266	11 mm	BL	20	-	10	

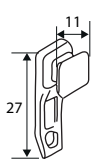

Nylon  
 BLANCO

### SOPORTE RIEL CT4



	Código	8431488	Medida	Acabado				€uros
	<b>39184</b>	391847	120x70 mm	ZN	-	50	250	

Espesor 3 mm

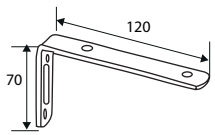

Acero  
 ZINCADO



**PERFIL CORTINA C/CINTA MACHO CT14**

	Código	8431488	Medida	Acabado			€uros
	<b>73343</b>	733432	3 mts	BL	-	5	-
	<b>73344</b>	733449	3 mts	PL	-	5	-

Aluminio

BLANCO PLATA

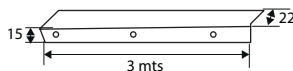

**CINTA CIERRE COSER CT15**

	Código	8431488	Medida/Tipo	Acabado			€uros
	<b>73345</b>	733456	20x25 mts/macho	BL	-	1	8
	<b>73346</b>	733463	20x25 mts/hembra	BL	-	1	8

Poliamida

BLANCO

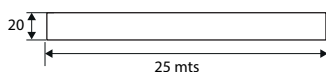

**CINTA CIERRE ADHESIVO CT16**

	Código	8431488	Medida/Tipo	Acabado			€uros
	<b>73347</b>	733470	20x25 mts/macho	BL	-	1	6
	<b>73348</b>	733487	20x25 mts/hembra	BL	-	1	6

Poliamida

BLANCO

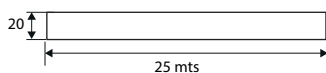

**TIRACORDÓN CORTINA C/AGUJERO CT18**

	Código	8431488	Medida	Acabado			€uros
Caja	<b>73358</b>	733586	45x30 mm	BL	-	25	125
Blister	<b>92336</b>	923369	45x30 mm	BL	2	-	10

Nylon

BLANCO

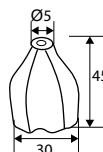



### CERRADURA MUEBLE CM1

	Código	8431488	Medida A	Acabado				€uros
Caja	11131	111315	26 mm	CB	-	1	12	
	11133	111339	32 mm	CB	-	1	12	
Blister	91095	910956	26 mm	CB	1	-	10	
	91096	910963	32 mm	CB	1	-	10	

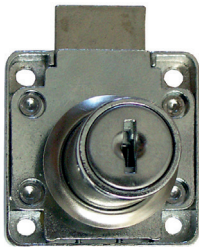

### CERRADURA MUEBLE CM1 (LLAVES IGUALES)

	Código	8431488	Medida A	Acabado				€uros
Caja	11132	111322	26 mm	CB	-	1	12	

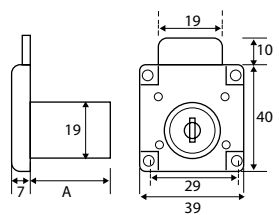

Zamak



### CERRADURA ARMARIO CM9

	Código	8431488	Medida	Acabado				€uros
Caja	11166	111667	22 mm	CB	-	1	12	
Blister	91878	918785	22 mm	CB	1	-	10	

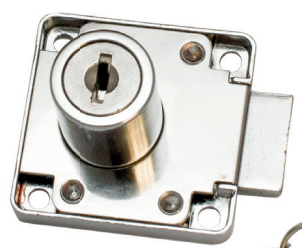

### CERRADURA ARMARIO CM9 (LLAVES IGUALES)

	Código	8431488	Medida	Acabado				€uros
Caja	11170	111704	22 mm	CB	-	1	12	

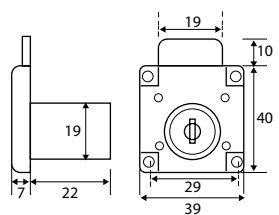

Zamak



### CERRADURA MUEBLE GANCHO CM2

	Código	8431488	Medida	Acabado				€uros
Caja	11147	111476	22 mm	CB	-	1	12	
Blister	91322	913223	22 mm	CB	1	-	10	

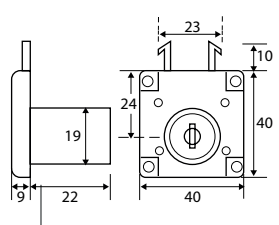

Zamak



### CERRADURA TAQUILLA CM14

	Código	8431488	Modelo	Acabado				€uros
Caja	11171	111711	MK1	CB	-	1	12	
	11172	111728	MK2	CB	-	1	12	
	11173	111735	MK3	CB	-	1	12	

Zamak



Tres grupos de amaestramiento  
Incluye resbalón

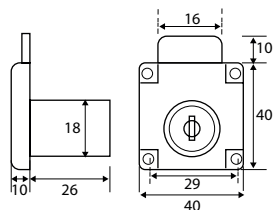

### LLAVE P/CERRADURA TAQUILLA CM14

	Código	8431488	Modelo	Acabado				€uros
Caja	11174	111742	MAESTRA MK1	VE	-	1	12	
	11175	111759	MAESTRA MK2	VE	-	1	12	
	11176	111766	MAESTRA MK3	VE	-	1	12	
	11177	111773	GRAN MAESTRA MK1, MK2, MK3	AZ	-	1	12	

Latón



### CERRADERO ESCUADRA CM11

	Código	8431488	Tipo	Acabado				€uros
Caja	11139	111391	ESCUADRA	CB	-	25	250	
Blister	91097	910970	ESCUADRA	CB	4	-	10	

Acero

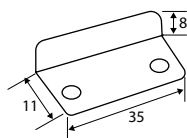

### LLAVES IGUALES P/CERRADURA MUEBLE CM12

	Código	8431488	Medida	Acabado				€uros
Caja	11143	111438	12 mm	NI	-	50	500	

Latón





## CERRADURA EMBUTIR CM15



	Código	8431488	Medida A	Acabado			€uros
Caja	11182	111827	15 mm	LP	-	12	120
	11183	111834	20 mm	LP	-	12	120
	11184	111841	25 mm	LP	-	12	120
	11185	111858	30 mm	LP	-	12	120
	11186	111865	35 mm	LP	-	12	120
	11187	111872	40 mm	LP	-	12	120
Blister	92338	923383	15 mm	LP	1	-	10
	92339	923390	20 mm	LP	1	-	10
	92340	923406	25 mm	LP	1	-	10
	92341	923413	30 mm	LP	1	-	10
	92342	923420	35 mm	LP	1	-	10
	92343	923437	40 mm	LP	1	-	10

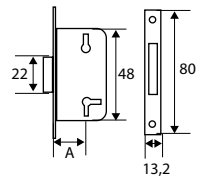

Llave 35 mm

Latón (Frente)



## CERRADURA SOBREPONER CM16

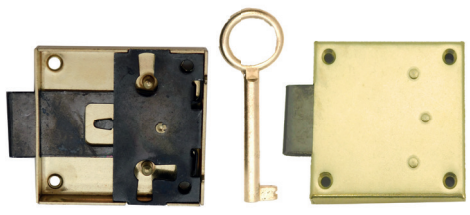

	Código	8431488	Medida A	Acabado			€uros
Caja	11188	111889	20 mm	LTD	-	12	120
	11189	111896	25 mm	LTD	-	12	120
	11190	111902	30 mm	LTD	-	12	120
	11191	111919	35 mm	LTD	-	12	120
	11192	111926	40 mm	LTD	-	12	120
Blister	92344	923444	20 mm	LTD	1	-	10
	92345	923451	25 mm	LTD	1	-	10
	92346	923468	30 mm	LTD	1	-	10
	92347	923475	35 mm	LTD	1	-	10
	92348	923482	40 mm	LTD	1	-	10

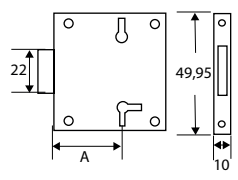

Llave 42 mm

Acero



## CERRADURA SOBREPONER CM17



	Código	8431488	Medida	Acabado			€uros
Caja	11180	111803	22 mm	LTD	-	12	120
Blister	92337	923376	22 mm	LTD	1	-	10

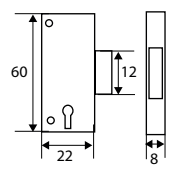

Llave 35 mm

Acero



## CERRADURA FALLEBA CM18



	Código	8431488	Medida	Acabado			€uros
Caja	11193	111933	18,5 mm	BL	-	12	120
	11194	111940	18,5 mm	MA	-	12	120
Blister	92349	923499	18,5 mm	BL	1	-	10
	92350	923505	18,5 mm	MA	1	-	10

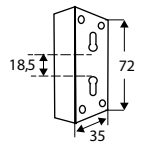

Llave 42 mm

Plástico



### CERRADURA MUEBLE HEBILLA CM19

	Código	8431488	Medida AxB	Acabado				Euros
Caja	11195	111957	80x32 mm	CB	-	1	20	
	11196	111964	94x32 mm	CB	-	1	20	
	11197	111971	110x40 mm	CB	-	1	20	
Blister	92351	923512	80x32 mm	CB	1	-	10	
	92352	923529	94x32 mm	CB	1	-	10	
	92353	923536	110x40 mm	CB	1	-	10	

Zamak

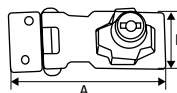

### ESCUDO BOCALLAVE ARMARIO EBA1

	Código	8431488	Medida	Acabado				Euros
Caja	30535	305356	31 mm	LP	-	10	250	
	30536	305363	31 mm	NS	-	10	250	

Latón

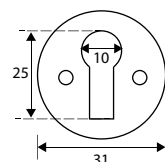

### CERRADURA PULSAR CM3

	Código	8431488	Medida	Acabado				Euros
Caja	11137	111377	26-35 mm	CB	-	1	12	
Blister	91098	910987	26-35 mm	CB	1	-	10	

Zamak

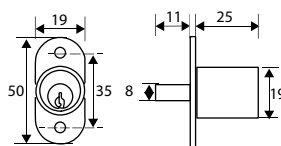

### CERRADURA ARCHIVADOR CM10

	Código	8431488	Medida	Acabado				Euros
Caja	11167	111674	18 mm	CB	-	1	12	
Blister	91982	919829	18 mm	CB	1	-	10	

Zamak

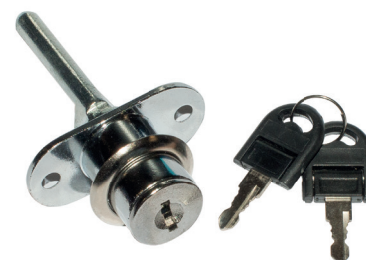
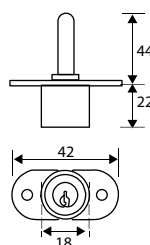



### CERRADURA VITRINA 1 PUERTA CM6

	Código	8431488	Medida	Acabado				€uros
	11148	111483	32x35 mm	CB	-	1	12	
<i>Blister</i>	91323	913230	32x35 mm	CB	1	-	10	

### CERRADURA VITRINA CM6 (LLAVES IGUALES)

	Código	8431488	Medida	Acabado				€uros
	11150	111506	32x35 mm	CB	-	1	12	

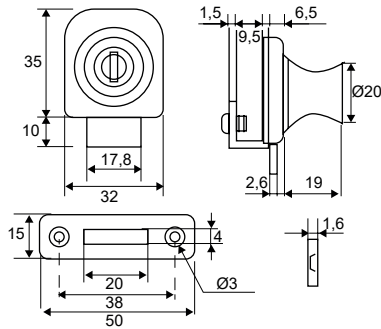

Zamak

CROMO BRILLO

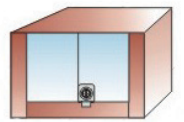

### CERRADURA VITRINA 2 PUERTAS CM7

	Código	8431488	Medida	Acabado				€uros
	11149	111490	48x35 mm	CB	-	1	12	
<i>Blister</i>	91324	913247	48x35 mm	CB	1	-	10	

### CERRADURA VITRINA CM7 (LLAVES IGUALES)

	Código	8431488	Medida	Acabado				€uros
	11151	111513	48x35 mm	CB	-	1	12	

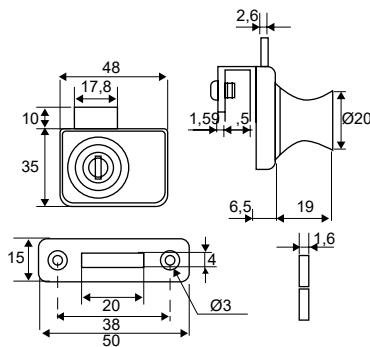

Zamak

CROMO BRILLO

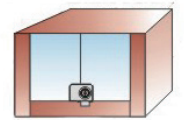

### CERRADURA VITRINA CM8

	Código	8431488	Medida	Acabado				€uros
	11138	111384	120 mm	CB	-	1	12	
<i>Blister</i>	91099	910994	120 mm	CB	1	-	10	

### CERRADURA VITRINA CM8 (LLAVES IGUALES)

	Código	8431488	Medida	Acabado				€uros
	11142	111421	120 mm	CB	-	1	12	

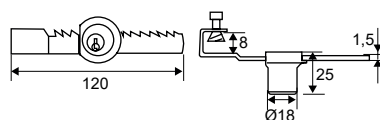

Zamak

CROMO BRILLO

### CERRADURA BUZÓN RECTA CM4

	Código	8431488	Medida A	Acabado				€uros
Caja	11134	111346	20 mm	CB	-	1	12	
	11136	111360	30 mm	CB	-	1	12	
Blister	91100	911007	20 mm	CB	1	-	10	
	91101	911014	30 mm	CB	1	-	10	



### CERRADURA BUZÓN CM4 (LLAVES IGUALES)

	Código	8431488	Medida A	Acabado				€uros
Caja	11145	111452	20 mm	CB	-	1	12	
	11169	111698	30 mm	CB	-	1	12	

Zamak

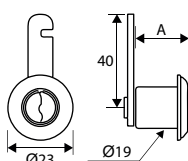

### CERRADURA BUZÓN CURVA CM5

	Código	8431488	Medida	Acabado				€uros
Caja	11135	111353	20 mm	CB	-	1	12	
Blister	91102	911021	20 mm	CB	1	-	10	



### CERRADURA BUZÓN CM5 (LLAVES IGUALES)

	Código	8431488	Medida	Acabado				€uros
Caja	11146	111469	20 mm	CB	-	1	12	

Zamak

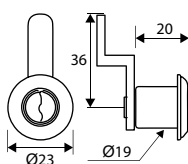

### CERRADURA COMBINACIÓN TAQUILLA CM13

	Código	8431488	Medida	Acabado				€uros
Caja	11178	111780	35 mm	CB	-	1	25	
	11179	111797	35 mm	NE	-	1	25	
Blister	92273	922737	35 mm	CB	1	-	10	
	92274	922744	35 mm	NE	1	-	10	

Zamak

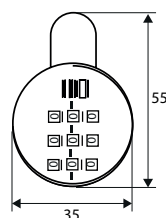



### RUEDA SUPERIOR ARMARIO RUA4



	Código	8431488	Medida	Acabado				€uros
Caja	<b>68217</b>	682174	46x39 mm	ZN	-	10	100	
Blister	<b>91649</b>	916491	46x39 mm	ZN	1	-	10	

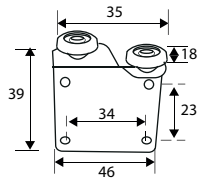

Acero  
  
ZINCADO

### RUEDA SUPERIOR ARMARIO RUA1



	Código	8431488	Medida	Acabado				€uros
Caja	<b>68214</b>	682143	65x55 mm	NE	-	10	50	
Blister	<b>91652</b>	916521	65x55 mm	NE	1	-	10	

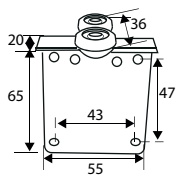

Acero  
  
NEGRO

### RUEDA SUPERIOR ARMARIO RUA2



	Código	8431488	Medida	Acabado				€uros
Caja	<b>68215</b>	682150	21x44 mm	ZN	-	10	100	
Blister	<b>91653</b>	916538	21x44 mm	ZN	1	-	10	

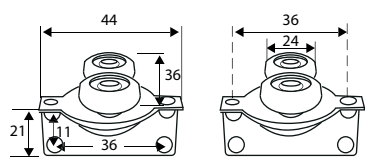

Acero  
  
ZINCADO

### FRENO SUPERIOR ARMARIO RUA6



	Código	8431488	Medida	Acabado				€uros
Caja	<b>68220</b>	682204	30x30 mm	ZN	-	10	100	
Blister	<b>91650</b>	916507	30x30 mm	ZN	1	-	10	

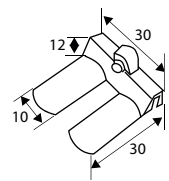

Acero  
  
ZINCADO

### RUEDA INFERIOR ARMARIO RUA3-M

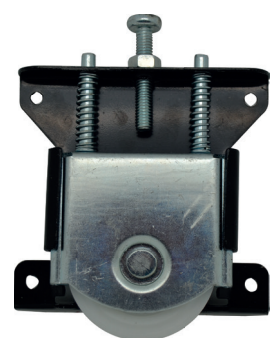

	Código	8431488	Tipo/Medida	Acabado				€uros
Caja	<b>68216</b>	682167	macho/85x80 mm	NE	-	10	50	
Blister	<b>91651</b>	916514	macho/85x80 mm	NE	1	-	10	

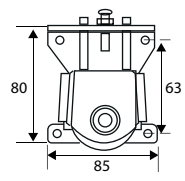

Acero  
  
NEGRO



**RUEDA INFERIOR ARMARIO RUAS**

	Código	8431488	Tipo/Medida	Acabado				€uros
Caja	<b>68218</b>	682181	macho/100x76 mm	ZN	-	10	30	
	<b>68219</b>	682198	hembra/100x76 mm	ZN	-	10	30	
Blister	<b>91647</b>	916477	macho/100x76 mm	ZN	1	-	10	
	<b>91648</b>	916484	Hembra/100x76 mm	ZN	1	-	10	

Acero



ZINCADO

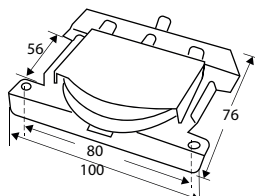

68218

68219

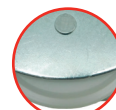

macho

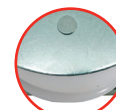

hembra

**POLEA PUERTA CORREDERA POL8**

	Código	8431488	Medida	Acabado				€uros
Caja	<b>89045</b>	890456	25 mm	LT	-	25	250	
	<b>89046</b>	890463	35 mm	LT	-	25	250	
Blister	<b>91550</b>	915500	25 mm	LT	2	-	10	
	<b>91551</b>	915517	35 mm	LT	2	-	10	

Acero



LATÓN

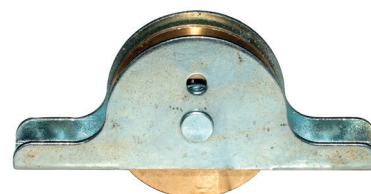
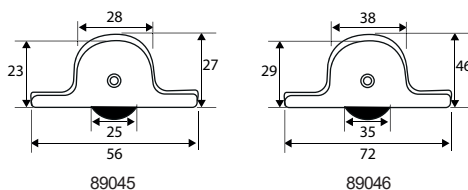

**CARRIL SUELO POL10**

	Código	8431488	Medida	Acabado				€uros
Caja	<b>89068</b>	890685	2 mts	LTD	-	5	-	
	<b>89069</b>	890692	2 mts	GV	-	5	-	

Acero



LATONADO GALVANIZADO

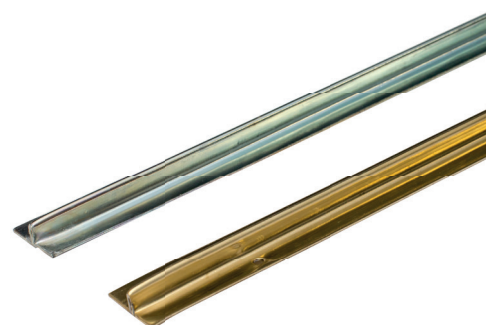
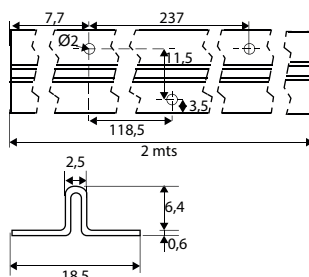

**POLEA SUPERIOR ESCUADRA POL9**

	Código	8431488	Medida	Acabado				€uros
Caja	<b>89082</b>	890821	43x12 mm	BC	-	25	625	
Blister	<b>91972</b>	919720	43x12 mm	BC	2	-	10	

Acero



BICROMATADO

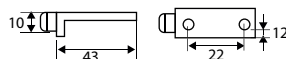



## CIERRE 2 RODILLOS GOMA IM1



	Código	8431488	Medida	Acabado				€uros
Caja	10089	100890	1 mm	BC	-	100	1000	
	10891	108919	1 mm	ZN	-	100	1000	
	10894	108940	1 mm	CU	-	100	1000	
Blister	90271	902715	1 mm	BC	2	-	10	
	90272	902722	1 mm	ZN	2	-	10	
	90273	902739	1 mm	CU	2	-	10	

Incluye tornillos en el blister

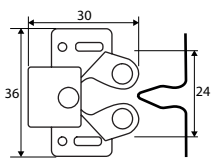

Acero  
 BICROMATADO ZINCADO CUERO

## CIERRE BOLA IM6

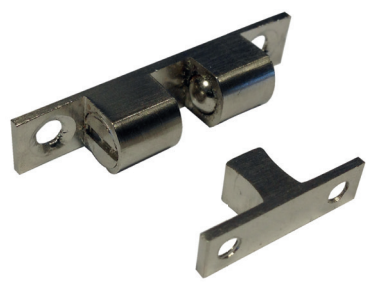

	Código	8431488	Medida A	Acabado				€uros
Caja	10244	102443	44 mm	LT	-	25	250	
	10250	102504	50 mm	LT	-	25	250	
	10270	102702	70 mm	LT	-	25	250	
	10245	102450	44 mm	NS	-	25	250	
	10246	102467	50 mm	NS	-	25	250	
	10247	102474	70 mm	NS	-	25	250	
Blister	90274	902746	44 mm	LT	2	-	10	
	90275	902753	50 mm	LT	2	-	10	
	90276	902760	70 mm	LT	2	-	10	
	91875	918754	44 mm	NS	2	-	10	
	91876	918761	50 mm	NS	2	-	10	
	91877	918778	70 mm	NS	2	-	10	

Incluye tornillos en el blister

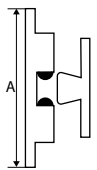

Latón  
 LATÓN NIQUEL SATINADO

## CIERRE MAGNÉTICO IM2



	Código	8431488	Medida	Acabado				€uros
Caja	10901	109015	42 mm	BL	-	100	1000	
	10911	109114	56 mm	BL	-	50	500	
	10902	109022	42 mm	MA	-	100	1000	
	10912	109121	56 mm	MA	-	50	500	
Blister	90281	902814	42 mm	BL	2	-	10	
	90282	902821	56 mm	BL	2	-	10	
	90283	902838	42 mm	MA	2	-	10	
	90284	902845	56 mm	MA	2	-	10	

Incluye tornillos en el blister

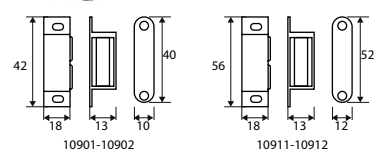

ABS  
 BLANCO MARRÓN

### IMÁN PIZARRA IM7

	Código	8431488	Medida	Acabado				€uros
Caja	10925	109251	25 mm	BL	-	100	500	
	10926	109268	25 mm	MA	-	100	500	
	10927	109275	25 mm	NE	-	100	500	
	10928	109282	25 mm	RO	-	100	500	
	10929	109299	25 mm	AM	-	100	500	
	10930	090047	25 mm	AZ	-	100	500	
	10931	090054	25 mm	SURTIDO	-	100	500	
Blister	90833	908335	25 mm	SURTIDO	4	-	10	

Nylon



### CIERRE MAGNÉTICO REGULABLE IM5

	Código	8431488	Medida	Acabado				€uros
Caja	10932	109329	30x30 mm	BL	-	50	500	
	10933	109336	30x30 mm	MA	-	50	500	
	10934	109343	30x30 mm	NE	-	50	500	
Blister	91210	912103	30x30 mm	BL	2	-	10	
	91211	912110	30x30 mm	MA	2	-	10	
	91212	912127	30x30 mm	NE	2	-	10	

ABS



Incluye placa y tornillos en el blister

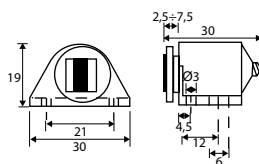

### CIERRE MAGNÉTICO C/MUELLE IM3

	Código	8431488	Medida	Acabado				€uros
Caja	10907	109077	47x43 mm	BL	-	100	1000	
	10908	109084	47x43 mm	NE	-	100	1000	
Blister	90285	902852	47x43 mm	BL	2	-	10	
	90286	902869	47x43 mm	NE	2	-	10	

ABS



Incluye placa y tornillos en el blister

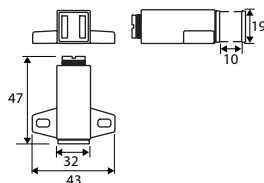

### CIERRE TOCA-TOCA IM4

	Código	8431488	Medida	Acabado				€uros
Caja	10903	109039	35x28 mm	BL	-	25	500	
	10904	109046	35x28 mm	MA	-	25	500	
Blister	90277	902777	35x28 mm	BL	2	-	10	
	90278	902784	35x28 mm	MA	2	-	10	

Acero/ABS

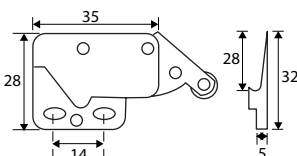



### AMORTIGUADOR EMBUTIR IM13



	Código	8431488	Medida	Acabado				€uros
Caja	<b>10895</b>	108957	50 mm	BL	-	25	250	
Blister	<b>90543</b>	905433	50 mm	BL	1	-	10	

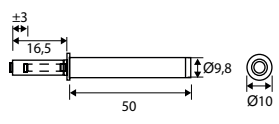

Nylon



### TOPE EMBUTIR AMORTIGUADOR IM14



	Código	8431488	Medida	Acabado				€uros
Caja	<b>10935</b>	109350	10 mm	GR	-	25	625	

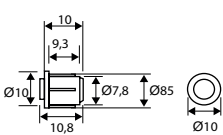

Nylon



### TOPE EMBUTIR IMÁN IM15



	Código	8431488	Medida	Acabado				€uros
Caja	<b>10936</b>	109367	10 mm	GR	-	25	625	

Incluye placa

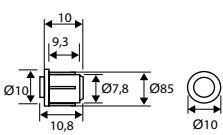

Nylon



### TOPE EMBUTIR AMORTIGUADOR REGULABLE IM16



	Código	8431488	Medida	Acabado				€uros
Caja	<b>10937</b>	109374	26 mm	GR	-	25	625	

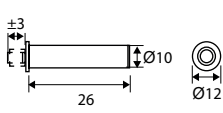

Nylon



### TOPE EMBUTIR IMÁN REGULABLE IM17



	Código	8431488	Medida	Acabado				€uros
Caja	<b>10938</b>	109381	26 mm	GR	-	25	625	

Incluye placa

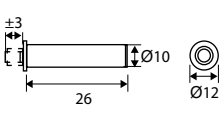

Nylon



**TOPE C/BASE AMORTIGUADOR IM18**

	Código	8431488	Medida	Acabado				€uros
Caja	10941	109411	12x32 mm	GR	-	25	625	

Nylon



GRIS

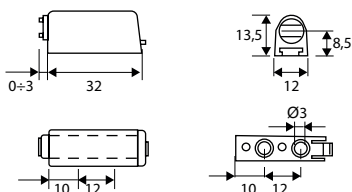

**TOPE C/BASE IMÁN IM19**

	Código	8431488	Medida	Acabado				€uros
Caja	10942	109428	12x32 mm	GR	-	25	250	

Nylon



GRIS

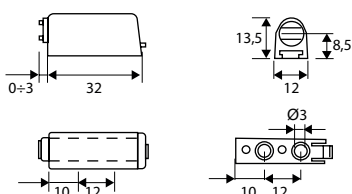

Incluye placa

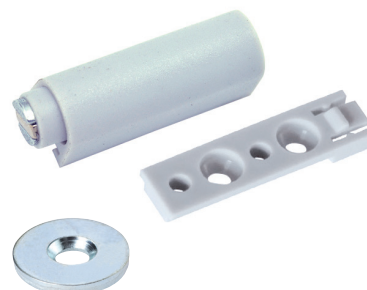

**TOPE ALAS AMORTIGUADOR IM20**

	Código	8431488	Medida	Acabado				€uros
Caja	10939	109398	28x30 mm	GR	-	25	625	

Nylon



GRIS

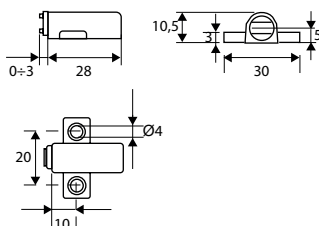

**TOPE ALAS IMÁN IM21**

	Código	8431488	Medida	Acabado				€uros
Caja	10940	109404	28x30 mm	GR	-	25	250	

Nylon



GRIS

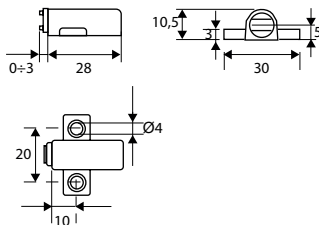

Incluye placa





### EXPULSOR C/BASE AMORTIGUADOR IM8



	Código	8431488	Medida/Expulsor	Acabado			€uros
Caja	10914	109145	75 mm/13 mm	GR	-	25	500
	10916	109169	125 mm/40 mm	GR	-	25	500
Blister	90531	905310	75 mm/13 mm	GR	1	-	10
	90532	905327	125 mm/40 mm	GR	1	-	10

Incluye tornillos en el blister

Nylon

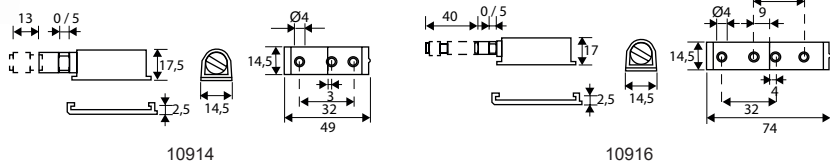

### EXPULSOR C/BASE IMÁN IM9

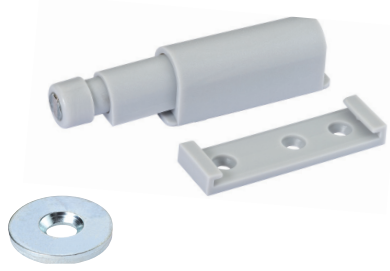

	Código	8431488	Medida/Expulsor	Acabado			€uros
Caja	10913	109138	75 mm/13 mm	GR	-	25	500
	10915	109152	125 mm/40 mm	GR	-	25	500
Blister	90535	905358	75 mm/13 mm	GR	1	-	10
	90536	905365	125 mm/40 mm	GR	1	-	10

Incluye placa y tornillos en el blister

Nylon

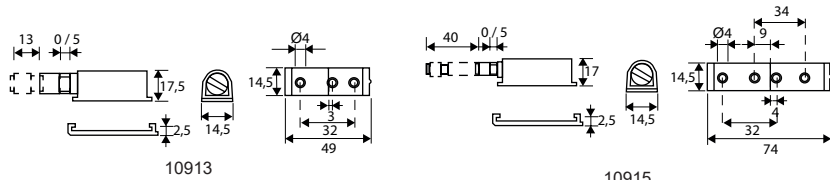

### EXPULSOR IMÁN ECO IM22



	Código	8431488	Medida	Acabado			€uros
Caja	10943	109435	80 mm/45 mm	GR	-	10	200

Presentación en tableta de 10 unidades

Nylon

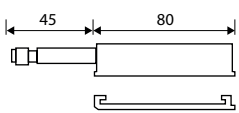

### EXPULSOR AMORTIGUADOR ECO IM23

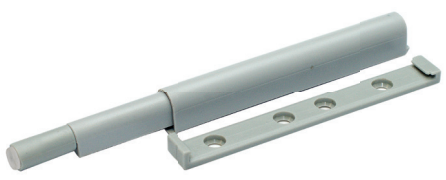

	Código	8431488	Medida	Acabado			€uros
Caja	10944	109442	80 mm/45 mm	GR	-	10	200

Presentación en tableta de 10 unidades

Nylon

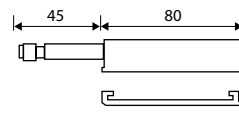

### EXPULSOR EMBUTIR AMORTIGUADOR IM10

	Código	8431488	Medida/Expulsor	Acabado			€uros
Caja	10922	109220	50 mm/16 mm	GR	-	25	250
	10918	109183	76 mm/37 mm	GR	-	25	250
Blister	90533	905334	50 mm/16 mm	GR	1	-	10
	90534	905341	76 mm/37 mm	GR	1	-	10

Nylon

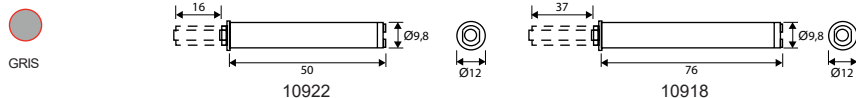

### EXPULSOR EMBUTIR IMÁN IM11

	Código	8431488	Medida/Expulsor	Acabado			€uros
Caja	10921	090030	50 mm/16 mm	GR	-	25	250
	10917	109176	76 mm/37 mm	GR	-	25	250
Blister	90537	905372	50 mm/16 mm	GR	1	-	10
	90538	905389	76 mm/37 mm	GR	1	-	10

Nylon

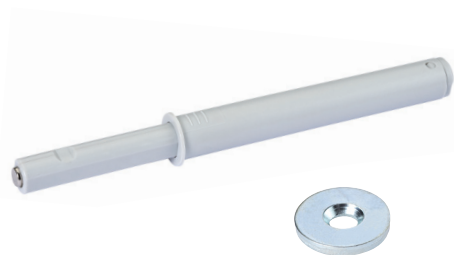
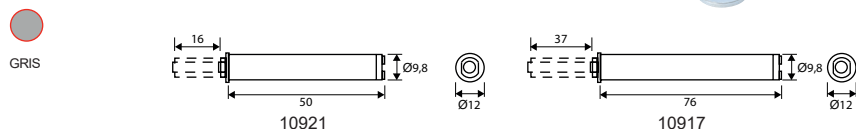

### EXPULSOR EMBUTIR REGULABLE AMORTIGUADOR IM38

	Código	8431488	Medida/Expulsor	Acabado			€uros
Caja	10924	109244	50 mm / 17 mm	GR	-	25	250
Blister	90540	905402	50 mm / 17 mm	GR	1	-	10

Nylon



### EXPULSOR EMBUTIR REGULABLE IMÁN IM12

	Código	8431488	Medida/Expulsor	Acabado			€uros
Caja	10923	109237	50 mm / 17 mm	GR	-	25	250
Blister	90539	905396	50 mm / 17 mm	GR	1	-	10

Nylon





### PLACA EMBUTIR P/IMÁN IM27

	Código	8431488	Tipo/Medida	Acabado				€uros
Caja	<b>00079</b>	000794	embutir/10 mm	NI	-	100	2500	

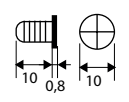

Acero  
 NIQUEL



### PLACA CLAVO P/IMÁN IM24

	Código	8431488	Tipo/Medida	Acabado				€uros
Caja	<b>00076</b>	000763	clavo/15 mm	ZN	-	100	2500	

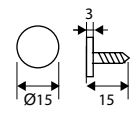

Acero  
 ZINCADO



### PLACA ADHESIVA P/IMÁN IM25

	Código	8431488	Tipo/Medida	Acabado				€uros
Caja	<b>00077</b>	000770	embutir/15 mm	NI	-	100	2500	

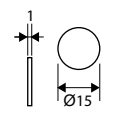

Acero  
 NIQUEL

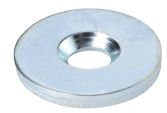

### PLACA ATORNILLAR P/IMÁN IM26

	Código	8431488	Tipo/Medida	Acabado				€uros
Caja	<b>00078</b>	000787	atornillar/15 mm	ZN	-	100	2500	<b>0,1080</b>

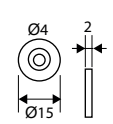

Acero  
 ZINCADO



10394

### NEODIMIO DISCO ADHESIVO IM29

	Código	8431488	Medida AxB	Máx. Carga	Acabado				€uros
Caja	<b>10394</b>	103945	9,5x1,5 mm	0,76 Kgs	NI	-	12	-	
	<b>10395</b>	103952	12,5x1,5 mm	1,60 Kgs	NI	-	12	-	
Blister	<b>92388</b>	923888	9,5x1,5 mm	0,76 Kgs	NI	6	-	10	
	<b>92389</b>	923895	12,5x1,5 mm	1,60 Kgs	NI	6	-	10	



10395

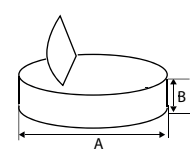

Neodimio  
 NIQUEL



NEODIMIO DISCO IM28

	Código	8431488	Medida Ax B	Máx. Carga	Acabado				€uros
Caja	10384	103846	5x3 mm	0,60 Kgs	NI	-	12	-	
	10385	103853	9,5x1,5 mm	0,74 Kgs	NI	-	12	-	
	10386	103860	10x3 mm	1,64 Kgs	NI	-	12	-	
	10387	103877	14x4 mm	3,40 Kgs	NI	-	12	-	
	10388	103884	20x5 mm	6,50 Kgs	NI	-	6	-	
	10389	103891	22x10 mm	12,00 Kgs	NI	-	6	-	
	10390	103907	28x10 mm	13,50 Kgs	NI	-	6	-	
	10391	103914	40x20 mm	11,80 Kgs	NI	-	1	-	
	10392	103921	50x25 mm	75,30 Kgs	NI	-	1	-	
	10393	103938	60x30 mm	200,00 Kgs	NI	-	1	-	
Blister	92381	923819	5x3 mm	0,60 Kgs	NI	6	-	10	
	92382	923826	9,5x1,5 mm	0,74 Kgs	NI	6	-	10	
	92383	923833	10x3 mm	1,64 Kgs	NI	6	-	10	
	92384	923840	14x4 mm	3,40 Kgs	NI	6	-	10	
	92385	923857	20x5 mm	6,50 Kgs	NI	3	-	10	
	92386	923864	22x10 mm	12,00 Kgs	NI	3	-	10	
	92387	923871	28x10 mm	13,50 Kgs	NI	3	-	10	

Neodimio

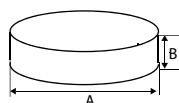

10384



10386



10392



10393

NEODIMIO BLOQUE IM30

	Código	8431488	Medida Ax BxC	Máx. Carga	Acabado				€uros
Caja	10396	103969	20x10x5 mm	5 Kgs	NI	-	12	-	
	10398	103983	30x9x2 mm	2,20 Kgs	NI	-	12	-	
	10399	103990	30x10x5 mm	2,20 Kgs	NI	-	12	-	
	10400	104003	40x20x5 mm	15,10 Kgs	NI	-	6	-	
	10401	104010	40x20x10 mm	19 Kgs	NI	-	6	-	
	92390	923901	20x10x5 mm	5 Kgs	NI	6	-	10	
	92391	923918	30x9x2 mm	2,20 Kgs	NI	6	-	10	
	92392	923925	30x10x5 mm	2,20 Kgs	NI	6	-	10	
	92393	923932	40x20x5 mm	15,10 Kgs	NI	3	-	10	
	92394	923949	40x20x10 mm	19 Kgs	NI	3	-	10	

Neodimio

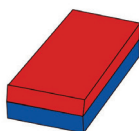
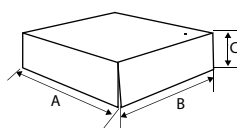
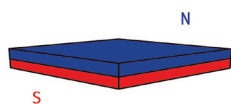

10396



10398



10400



10401



10404



10421



10426

## NEODIMIO ARO AVELLANADO IM31

	Código	8431488	Medida Ax B	Máx. Carga	Acabado				€uros
Caja	10404	104041	10x3 mm (8-4)	1,45 Kgs	NI	-	12	-	
	10418	104188	12x6 mm (8-4)	2,15 Kgs	NI	-	12	-	
	10405	104058	15x4 mm (8-4)	3,55 Kgs	NI	-	12	-	
	10406	104065	18x4 mm (8-4)	4,40 Kgs	NI	-	12	-	
	10419	104195	20x3 mm (8-4)	4,00 Kgs	NI	-	12	-	
	10420	104201	25x5 mm (6,7-3,1)	8,55 Kgs	NI	-	6	-	
	10426	104263	25x7 mm (4,5-0,9)	14,00 Kgs	NI	-	6	-	
	10421	104218	30x5 mm (12-6)	9,60 Kgs	NI	-	6	-	
	10425	104256	32x7 mm (5,5-1,1)	25,00 Kgs	NI	-	6	-	
Blister	92395	923956	10x3 mm (8-4)	1,45 Kgs	NI	6	-	10	
	92396	923963	12x6 mm (8-4)	2,15 Kgs	NI	6	-	10	
	92397	923970	15x4 mm (8-4)	3,55 Kgs	NI	6	-	10	
	92398	923987	18x4 mm (8-4)	4,40 Kgs	NI	6	-	10	
	92399	923994	20x3 mm (8-4)	4,00 Kgs	NI	6	-	10	
	92400	924007	25x5 mm (6,7-3,1)	8,55 Kgs	NI	3	-	10	
	92401	924014	30x5 mm (12-6)	9,60 Kgs	NI	3	-	10	
	92402	924021	32x7 mm (5,5-1,1)	25,00 Kgs	NI	3	-	10	

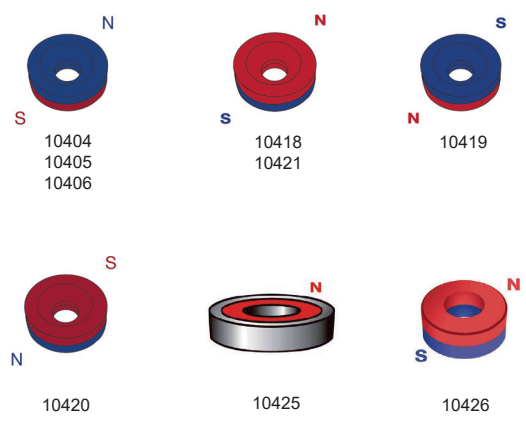
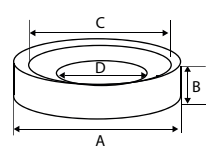

Neodimio   
 NIQUEL

## NEODIMIO GANCHO IM32



	Código	8431488	Medida Ax B	Máx. Carga	Acabado				€uros
Caja	10408	104089	16x9,5 mm	4,30 Kgs	NI	-	6	-	
	10409	104096	20x14 mm	12,00 Kgs	NI	-	6	-	
	10410	959337	25x20 mm	20,00 Kgs	NI	-	6	-	

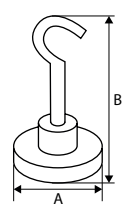

Métrica gancho  
10408: M4  
10409: M4  
10410: M4

Neodimio   
 NIQUEL

### FERRITA DISCO IM34

	Código	8431488	Medida AxB	Máx. Carga	Acabado				€uros
Caja	10411	104119	12x2,5 mm	0,57 Kgs	NE	-	12	-	
	10413	104133	22x3 mm	1,00 Kg	NE	-	12	-	
	10414	104140	25x5 mm	2,20 Kgs	NE	-	12	-	
Blister	92403	924038	12x2,5 mm	0,57 Kgs	NE	6	-	10	
	92404	924045	22x3 mm	1,00 Kg	NE	6	-	10	
	92405	924052	25x5 mm	2,20 Kgs	NE	6	-	10	



10411



10414

Ferrita



NEGRO

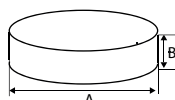
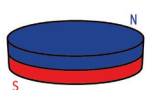

### FERRITA BLOQUE IM35

	Código	8431488	Medida AxB	Máx. Carga	Acabado				€uros
Caja	10415	104157	20x10x5 mm	0,80 Kgs	NE	-	12	-	
	10416	104164	40x20x10 mm	1,40 Kgs	NE	-	12	-	
Blister	92406	924069	20x10x5 mm	0,80 Kgs	NE	6	-	10	
	92407	924076	40x20x10 mm	1,40 Kgs	NE	6	-	10	



10415



10416

Ferrita



NEGRO

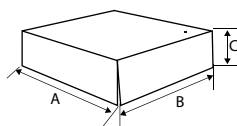
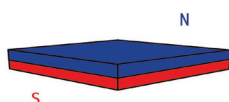

### IMÁN PETANCA NEODIMIO IM33

	Código	8431488	Medida	Máx. Carga	Acabado				€uros
Caja	10407	104072	22x15 mm	3,50 Kgs	NE	-	15	-	
Blister	92379	923796	22x15 mm	3,50 Kgs	NE	2	-	10	

Neodimio



NEGRO

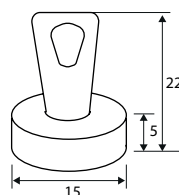



### LÁGRIMA ADHESIVA LGM1



	Código	8431488	Medida Ax B	Acabado				€uros
Caja	<b>61921</b>	619217	7x1,5 mm	TR	-	1000	20000	
	<b>61925</b>	619255	8x2,2 mm	TR	-	1000	20000	
	<b>61926</b>	619262	10x1,5 mm	TR	-	1000	20000	
	<b>61922</b>	619224	10x3 mm	TR	-	1000	20000	
Blister	<b>90505</b>	905051	7x1,5 mm	TR	50	-	10	
	<b>91413</b>	914138	8x2,2 mm	TR	25	-	10	
	<b>91414</b>	914145	10x1,5 mm	TR	25	-	10	
	<b>90506</b>	905068	10x3 mm	TR	25	-	10	

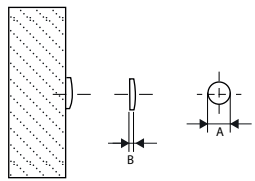

Goma  
  
TRANSPARENTE

### LÁGRIMA ADHESIVA LGM2



	Código	8431488	Medida	Acabado				€uros
Caja	<b>61923</b>	619231	13x4 mm	TR	-	1000	20000	
Blister	<b>90507</b>	905075	13x4 mm	TR	20	-	10	

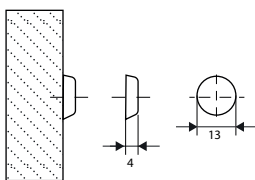

Goma  
  
TRANSPARENTE

### LÁGRIMA ADHESIVA LGM3



	Código	8431488	Medida	Acabado				€uros
Caja	<b>61927</b>	619279	16x7,9 mm	TR	-	160	3200	
Blister	<b>91451</b>	914510	16x7,9 mm	TR	8	-	10	

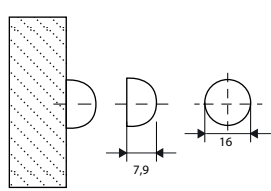

Goma  
  
TRANSPARENTE

### LÁGRIMA ADHESIVA LGM4



	Código	8431488	Medida	Acabado				€uros
Caja	<b>61928</b>	619286	20x6,2 mm	TR	-	105	2100	
Blister	<b>91415</b>	914152	20x6,2 mm	TR	6	-	10	

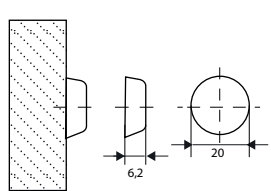

Goma  
  
TRANSPARENTE

### LÁGRIMA ADHESIVA LGM5

	Código	8431488	Medida	Acabado			€uros
Caja	<b>61929</b>	619293	10x10x2,5 mm	TR	-	550	11000
Blister	<b>91416</b>	914169	10x10x2,5 mm	TR	25	-	10

Goma



TRANSPARENTE

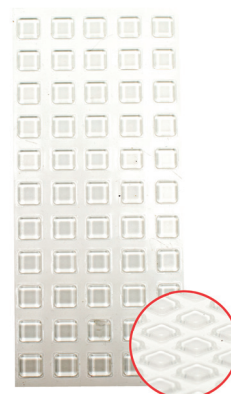
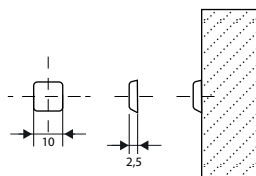

### LÁGRIMA ADHESIVA LGM6

	Código	8431488	Medida	Acabado			€uros
Caja	<b>61930</b>	619309	12,5x12,5x5,8 mm	TR	-	480	9600
Blister	<b>91417</b>	914176	12,5x12,5x5,8 mm	TR	20	-	10

Goma



TRANSPARENTE

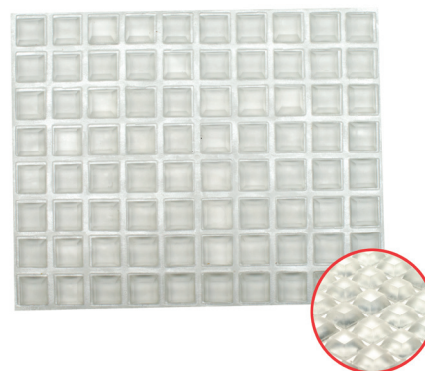
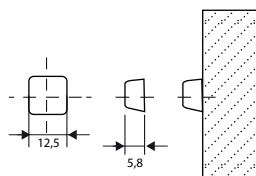

### LÁGRIMA ADHESIVA LGM7

	Código	8431488	Medida	Acabado			€uros
Caja	<b>61932</b>	619323	20,5x20,5x7,5 mm	TR	-	90	1800
Blister	<b>91418</b>	914183	20,5x20,5x7,5 mm	TR	6	-	10

Goma



TRANSPARENTE

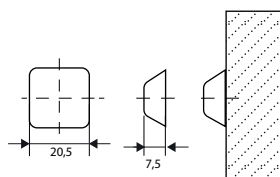

### LÁGRIMA EMBUTIR BIMATERIAL LGM8

	Código	8431488	Medida	Acabado			€uros
Caja	<b>61924</b>	619248	8,8x2,5 mm	TR	-	1000	10000
Blister	<b>90632</b>	906324	8,8x2,5 mm	TR	20	-	10

PVC



TRANSPARENTE

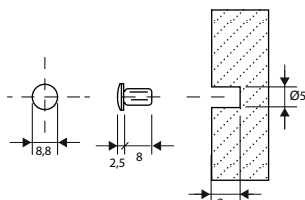

(Taladro 5 mm)







## TAPÓN ADHESIVO 13 MM TPN1

Acabado (13 mm)	1000 uds			100 uds			20 uds		
	Código	8431488	€uros	Código	8431488	€uros	Código	8431488	€uros
BLANCO	61941	619415		61901	619019		90906	909066	
BLANCO PORO	61942	619422		61902	619026		90907	909073	
NEGRO	61943	619439		61903	619033		90908	909080	
NEGRO PORO	61944	619446		61904	619040		90909	909097	
GRIS	61945	619453		61905	619057		90910	909103	
CREMA	61946	619460		61906	619064		90911	909110	
HAYA	61947	619477		61907	619071		90912	909127	
ROBLE	61948	619484		61908	619088		90913	909134	
PINO	61949	619491		61909	619095		90914	909141	
NOGAL	61950	619507		61910	619101		90915	909158	
CEREZO	61951	619514		61911	619118		90916	909165	
MAPLE	61952	619521		61912	619125		90917	909172	
SAPELI	61953	619538		61913	619132		90918	909189	
WENGUE	61954	619545		61914	619149		90919	909196	
PLATA	61955	619552		61915	619156		90920	909202	
PINTABLE	61956	619569		91429	914299		91420	914206	
CROMADO	61957	619576		91430	914305		91421	914213	
CAOBA	61958	619583		91431	914312		91422	914220	
CEREZO CLARO	61959	619590		91432	914329		91423	914237	
PINO CLARO	61960	619606		91433	914336		91424	914244	
ROBLE CLARO	61972	619729		91434	914343		91425	914251	
ROBLE OSCURO	61973	619736		91435	914350		91426	914268	
CENIZA	61974	619743		91436	914367		91427	914275	
GRIS BEIGE	61975	619750		91437	914374		91428	914282	
GRIS MARENGO	61936	619361		61916	619163		61918	619187	
ANTRACITA	61937	619378		61917	619170		61919	619194	
TEXTIL OSCURO	61938	619385		91823	918235		91826	918266	
TEXTIL CLARO	61939	619392		91824	918242		91827	918273	
TEXTIL BEIGE	61940	619408		91825	918259		91828	918280	
ALUMINIO	62021	620213		62039	620398		62030	620305	
ABEDUL	62022	620220		62040	620404		62031	620312	
NUEZ	62023	620237		62041	620411		62032	620329	
OLMO CLARO	62024	620244		62042	620428		62033	620336	
OLMO OSCURO	62025	620251		62043	620435		62034	620343	
ROBLE BLANCO	62026	620268		62044	620442		62035	620350	
SICOMORO	62027	620275		62045	620459		62036	620367	
WENGUE CENIZA	62028	620282		62046	620466		62037	620374	
FRESNO	62029	620299		62047	620473		62038	620381	

COMPLEMENTOS ARMARIO Y MUEBLE



TAPÓN ADHESIVO 17 MM TPN2

Acabado (17 mm)	600 uds 			60 uds 			20 uds 		
	Código	8431488	€uros	Código	8431488	€uros	Código	8431488	€uros
BLANCO	61981	619811		61961	619613		91438	914381	
NEGRO	61982	619828		61962	619620		91439	914398	
GRIS	61983	619835		61963	619637		91440	914404	
CREMA	61984	619842		61964	619644		91441	914411	
HAYA	61985	619859		61965	619651		91442	914428	
ROBLE	61986	619866		61966	619668		91443	914435	
PINO	61987	619873		61967	619675		91444	914442	
NOGAL	61988	619880		61968	619682		91445	914459	
MAPLE	61989	619897		61969	619699		91446	914466	
SAPALI	61990	619903		61970	619705		91447	914473	
WENGUE	61991	619910		61971	619712		91448	914480	
CEREZO	61992	619927		91450	914503		91449	914497	
TEXTIL OSCURO	62006	620060		62011	620114		62016	620169	
TEXTIL CLARO	62007	620077		62012	620121		62017	620176	
TEXTIL BEIGE	62008	620084		62013	620138		62018	620183	
GRIS MARENGO	62009	620091		62014	620145		62019	620190	
ANTRACITA	62010	620107		62015	620152		62020	620206	

PVC

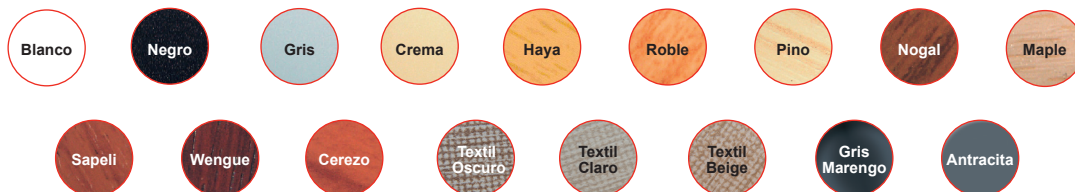

TAPÓN ADHESIVO 25 MM TPN3

Acabado (25 mm)	300 uds 			12 uds 		
	Código	8431488	€uros	Código	8431488	€uros
BLANCO	61999	619996		91215	912158	
NEGRO	62000	620008		91216	912165	
GRIS	62001	620015		91217	912172	
HAYA	62002	620022		91218	912189	
ROBLE	62003	620039		91219	912196	
CEREZO	62004	620046		91220	912202	
WENGUE	62005	620053		91221	912219	

PVC





### TAPÓN ADHESIVO P/BISAGRA TPN4

	Código	843 I 488	Medida	Acabado			€uros
Caja	61995	619958	35 mm	BL	-	200	-
	61996	619965	35 mm	GR	-	200	-
	61997	619972	35 mm	RB	-	200	-
	61998	619989	35 mm	HY	-	200	-
Blíster	90733	907338	35 mm	BL	8	-	10
	90734	907345	35 mm	GR	8	-	10
	90735	907352	35 mm	RB	8	-	10
	90736	907369	35 mm	HY	8	-	10

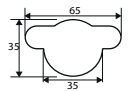

PVC

BLANCO GRIS ROBLE HAYA

### TAPÓN PLÁSTICO P/TORNILLO TPN5

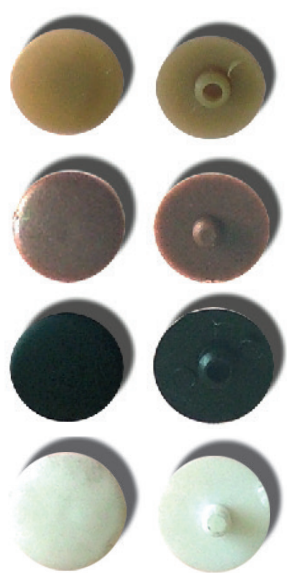

	Código	843 I 488	Medida Allen (A)	Acabado			€uros
Caja	60001	600017	5 mm	BL	-	1000	10000
	60002	600024	5 mm	NE	-	1000	10000
	60003	600031	5 mm	MA	-	1000	10000
	60004	600048	5 mm	BE	-	1000	10000
	60101	601014	7 mm	BL	-	1000	10000
	60102	601021	7 mm	NE	-	1000	10000
	60103	601038	7 mm	MA	-	1000	10000
	60104	601045	7 mm	BE	-	1000	10000
Blíster	91703	917030	5 mm	BL	25	-	10
	91704	917047	5 mm	NE	25	-	10
	91705	917054	5 mm	MA	25	-	10
	91706	917061	5 mm	BE	25	-	10
	91707	917078	7 mm	BL	25	-	10
	91708	917085	7 mm	NE	25	-	10
	91709	917092	7 mm	MA	25	-	10
	91710	917108	7 mm	BE	25	-	10



Polietileno

BLANCO NEGRO MARRÓN BEIGE

### TAPÓN PLÁSTICO ENVOLVENTE TPN6



	Código	843 I 488	Medida	Acabado			€uros
Caja	60105	601052	14 mm	BL	-	100	2500
	60106	601069	14 mm	MA	-	100	2500
	60107	601076	14 mm	GR	-	100	2500
Blíster	91222	912226	14 mm	BL	8	-	10
	91223	912233	14 mm	MA	8	-	10
	91224	912240	14 mm	GR	8	-	10

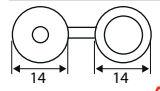

Polipropileno

BLANCO MARRÓN GRIS

### TAPÓN MÓDULO CREMALLERA TPN7

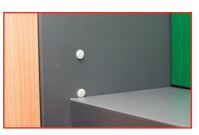

	Código	843 I 488	Medida	Acabado			€uros
Caja	60108	601083	5 mm	BL	-	1000	10000
	60109	601090	5 mm	GR	-	1000	10000
Blíster	91987	919874	5 mm	BL	10	-	10
	91988	919881	5 mm	GR	10	-	10

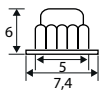

Polietileno

BLANCO GRIS



**CANTO MELAMINA CAN2**

	Código	8431488	Medida	Acabado				€uros
	62100	621005	22x5 mts	BLANCO	-	1	10	
	62101	621012	22x5 mts	NEGRO	-	1	10	
	62102	621029	22x5 mts	GRIS	-	1	10	
	62103	621036	22x5 mts	PINO	-	1	10	
	62104	621043	22x5 mts	HAYA	-	1	10	
	62105	621050	22x5 mts	WENGUE	-	1	10	
	62106	621067	22x5 mts	NOGAL	-	1	10	
	62107	621074	22x5 mts	SAPELI	-	1	10	
	62108	621081	22x5 mts	CEREZO	-	1	10	
	62109	621098	22x5 mts	ROBLE	-	1	10	
	62111	621111	22x5 mts	ROBLE CLARO	-	1	10	
	62112	621128	22x5 mts	ROBLE OSCURO	-	1	10	
Blister	91606	916064	22x5 mts	BLANCO	1	-	10	
	91607	916071	22x5 mts	NEGRO	1	-	10	
	91608	916088	22x5 mts	GRIS	1	-	10	
	91609	916095	22x5 mts	PINO	1	-	10	
	91610	916101	22x5 mts	HAYA	1	-	10	
	91611	916118	22x5 mts	WENGUE	1	-	10	
	91612	916125	22x5 mts	NOGAL	1	-	10	
	91613	916132	22x5 mts	SAPELI	1	-	10	
	91614	916149	22x5 mts	CEREZO	1	-	10	
	91632	916323	22x5 mts	ROBLE	1	-	10	
	91633	916330	22x5 mts	ROBLE CLARO	1	-	10	
	91634	916347	22x5 mts	ROBLE OSCURO	1	-	10	



**CANTO ADHESIVO CAN1**

	Código	8431488	Medida	Acabado				€uros
	62113	621135	19x5 mts	BLANCO	-	1	10	
	62114	621142	19x5 mts	NEGRO	-	1	10	
	62115	621159	19x5 mts	GRIS	-	1	10	
	62116	621166	19x5 mts	PINO	-	1	10	
	62117	621173	19x5 mts	HAYA	-	1	10	
	62118	621180	19x5 mts	WENGUE	-	1	10	
	62119	621197	19x5 mts	NOGAL	-	1	10	
	62121	621210	19x5 mts	SAPELI	-	1	10	
	62122	621227	19x5 mts	CEREZO	-	1	10	
	62123	621234	19x5 mts	ROBLE	-	1	10	
	62124	621241	19x5 mts	ROBLE CLARO	-	1	10	
	62126	621265	19x5 mts	ROBLE OSCURO	-	1	10	
Blister	91635	916354	19x5 mts	BLANCO	1	-	10	
	91636	916361	19x5 mts	NEGRO	1	-	10	
	91637	916378	19x5 mts	GRIS	1	-	10	
	91638	916385	19x5 mts	PINO	1	-	10	
	91639	916392	19x5 mts	HAYA	1	-	10	
	91640	916408	19x5 mts	WENGUE	1	-	10	
	91641	916415	19x5 mts	NOGAL	1	-	10	
	91642	916422	19x5 mts	SAPELI	1	-	10	
	91643	916439	19x5 mts	CEREZO	1	-	10	
	91644	916446	19x5 mts	ROBLE	1	-	10	
91645	916453	19x5 mts	ROBLE CLARO	1	-	10		
91646	916460	19x5 mts	ROBLE OSCURO	1	-	10		



Melamina



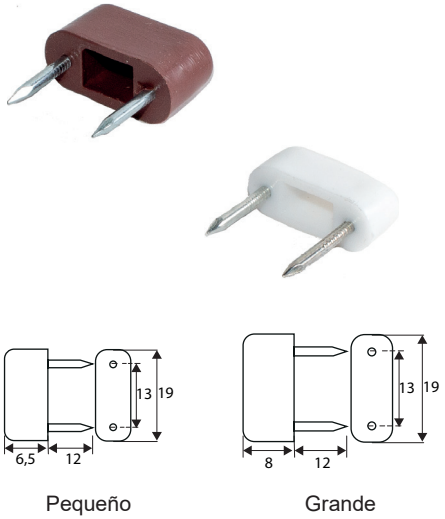

### TOPE 2 PUNTAS TPM1

	Código	843 I 488	Medida	Acabado				€uros
Caja	60601	606019	pequeño	BL	-	1000	10000	
	60603	606033	pequeño	BL	-	100	5000	
	60611	606118	grande	BL	-	1000	10000	
	60613	606132	grande	BL	-	100	5000	
	60602	606026	pequeño	MA	-	1000	10000	
	60604	606040	pequeño	MA	-	100	5000	
	60612	606125	grande	MA	-	1000	10000	
Blister	60614	606149	grande	MA	-	100	5000	
	90370	903705	pequeño	BL	8	-	10	
	90371	903712	grande	BL	8	-	10	
	90372	903729	pequeño	MA	8	-	10	
	90373	903736	grande	MA	8	-	10	

Polipropileno



### PORTAESTANTE VITRINA PES

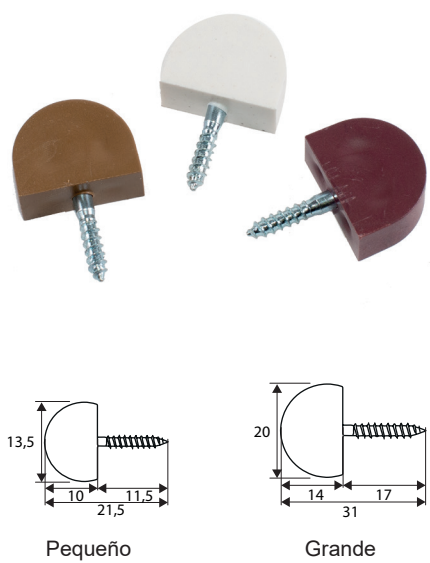

	Código	843 I 488	Medida	Acabado				€uros
Caja	60401	604015	pequeño	BL	-	1000	10000	
	60405	604053	pequeño	BL	-	100	5000	
	60411	604114	grande	BL	-	500	5000	
	60415	604152	grande	BL	-	100	5000	
	60402	604022	pequeño	MA	-	1000	10000	
	60406	604060	pequeño	MA	-	100	5000	
	60412	604121	grande	MA	-	500	5000	
	60416	604169	grande	MA	-	100	5000	
	60403	604039	pequeño	BE	-	1000	10000	
	60407	604077	pequeño	BE	-	100	5000	
	60413	604138	grande	BE	-	500	5000	
	60417	604176	grande	BE	-	100	5000	
	60418	604183	pequeño	GR	-	1000	10000	
	60420	604206	pequeño	GR	-	100	5000	
	60419	604190	grande	GR	-	500	5000	
60421	604213	grande	GR	-	100	5000		
Blister	90363	903637	pequeño	BL	8	-	10	
	90362	903620	grande	BL	4	-	10	
	90365	903651	pequeño	MA	8	-	10	
	90364	903644	grande	MA	4	-	10	
	90367	903675	pequeño	BE	8	-	10	
	90366	903668	grande	BE	4	-	10	
	92270	922706	pequeño	GR	8	-	10	
92271	922713	grande	GR	4	-	10		

Polipropileno



### PORTAESTANTE CLAVAR PE16



	Código	843 I 488	Medida	Acabado				€uros
Caja	60701	607016	15 mm	BL	-	1000	10000	
	60702	607023	15 mm	MA	-	1000	10000	

Polietileno



### PORTAESTANTE ARANDELA PE3

	Código	8431488	Medida	Acabado				€uros
Caja	31011	310114	5x16 mm	LTD	-	1000	5000	
	31021	310213	5x16 mm	LTD	-	100	5000	
	31013	310138	5x16 mm	ZN	-	1000	5000	
	31023	310237	5x16 mm	ZN	-	100	10000	
Blister	90352	903521	5x16 mm	LTD	12	-	10	
	90353	903538	5x16 mm	ZN	12	-	10	

Acero

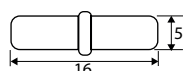

### PORTAESTANTE ARANDELA PE3

	Código	8431488	Medida A	Acabado				€uros
Caja	31017	310176	3-5x16 mm	ZN	-	1000	10000	
	31014	310145	4-5x16 mm	ZN	-	1000	10000	
Blister	92374	923741	3-5x16 mm	ZN	12	-	10	
	90725	907253	4-5x16 mm	ZN	12	-	10	

Acero

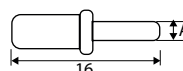

### PORTAESTANTE CRISTAL PE4

	Código	8431488	Medida A	Acabado				€uros
Caja	31016	310169	3x16 mm	ZN	-	500	12500	
	31015	310152	5x16 mm	ZN	-	500	12500	

Acero

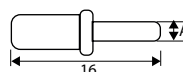

### PORTAESTANTE PE2

	Código	8431488	Medida	Acabado				€uros
Caja	31609	316093	5 mm	NI	-	100	1000	
Blister	91714	917146	5 mm	NI	4	-	10	

Zamak

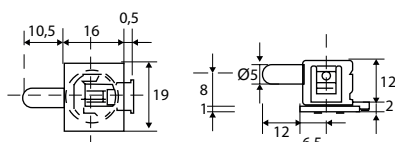



### PORTAESTANTE SAFETY PE6



	Código	8431488	Medida	Acabado				€uros
Caja	60301	603018	5 mm	BL	-	1000	5000	
	60307	603070	5 mm	BL	-	100	5000	
	60302	603025	5 mm	MA	-	1000	5000	
	60308	603087	5 mm	MA	-	100	5000	
	60303	603032	5 mm	TR	-	1000	5000	
Blister	90359	903590	5 mm	BL	8	-	10	
	90360	903606	5 mm	MA	8	-	10	
	90361	903613	5 mm	TR	8	-	10	

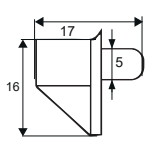

Polipropileno  
 BLANCO MARRÓN TRANSPARENTE

### PORTAESTANTE SAFETY PE6



	Código	8431488	Medida	Acabado				€uros
Caja	60304	603049	3 mm	TR	-	1000	5000	
	60311	603117	3 mm	TR	-	100	5000	
Blister	90723	907239	3 mm	TR	8	-	10	

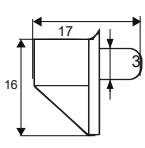

Polipropileno  
 TRANSPARENTE

### PORTAESTANTE SAFETY LARGO PE7



	Código	8431488	Medida	Acabado				€uros
Caja	60305	603056	5 mm	TR	-	500	2500	
Blister	90724	907246	5 mm	TR	4	-	10	

Tablero 16 mm

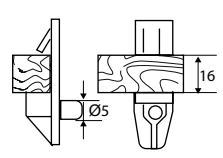

Polipropileno  
 TRANSPARENTE

### PORTAESTANTE ESCUADRA Y CASQUILLO PE8



	Código	8431488	Tipo	Acabado				€uros
Caja	60201	602011	portaestante	BL	-	1000	10000	
	60211	602110	casquillo	BL	-	1000	10000	
	60202	602028	portaestante	MA	-	1000	10000	
	60212	602127	casquillo	MA	-	1000	10000	
Blister	90368	903682	portaestante + casquillo	BL	8	-	10	
	90369	903699	portaestante + casquillo	MA	8	-	10	

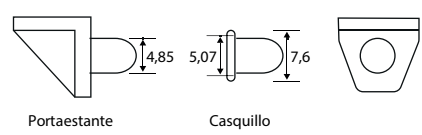

Polipropileno  
 BLANCO MARRÓN

### PORTAESTANTE PALETA PE1

	Código	8431488	Medida	Acabado				€uros
Caja	31606	316062	5 mm	NI	-	100	2500	
Blister	91711	917115	5 mm	NI	8	-	10	

Zamak



NIQUEL

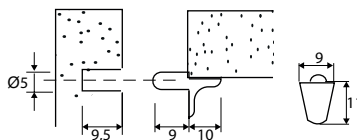

### PORTAESTANTE PERNO PE17

	Código	8431488	Medida	Acabado				€uros
Caja	31607	316079	5 mm	NI	-	100	2500	
Blister	91712	917122	5 mm	NI	8	-	10	

Zamak



NIQUEL

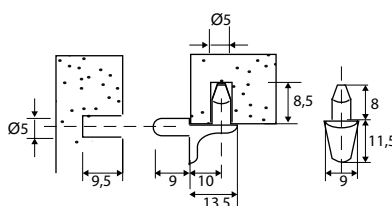

### PORTAESTANTE EURO PE18

	Código	8431488	Medida	Acabado				€uros
Caja	31608	316086	5 mm	NI	-	100	2500	
Blister	91713	917139	5 mm	NI	8	-	10	

Zamak



NIQUEL

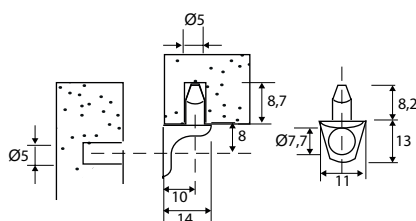

### PORTAESTANTE CRISTAL PE9

	Código	8431488	Medida	Acabado				€uros
Caja	31603	316031	5 mm	NI	-	500	2500	
Blister	90635	906355	5 mm	NI	4	-	10	

Zamak



NIQUEL

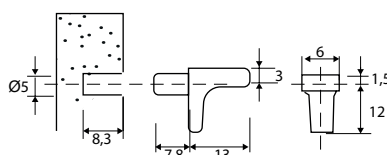



### PORTAESTANTE Y CASQUILLO PRESIÓN PE11



	Código	8431488	Tipo	Acabado				€uros
Caja	31511	315119	portaestante	LT	-	250	2500	
	31521	315218	casquillo	LT	-	500	5000	
	31512	315126	portaestante	NI	-	250	2500	
	31522	315225	casquillo	NI	-	500	5000	

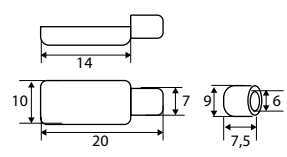

Latón  
 LATÓN NÍQUEL

### PORTAESTANTE Y CASQUILLO ESTAMPADO PE12



	Código	8431488	Tipo	Acabado				€uros
Caja	31311	313115	portaestante	LTD	-	500	2500	
	31321	313214	casquillo	LTD	-	1000	5000	
Blister	90347	903477	portaestante + casquillo	LTD	4	-	10	

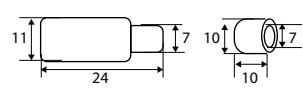

Acero  
 LATONADO

### PORTAESTANTE Y CASQUILLO ROSCADO PE13

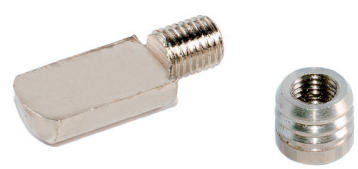

	Código	8431488	Medida	Acabado				€uros
Caja	31411	314112	portaestante	LT	-	250	2500	
	31421	314211	casquillo	LT	-	500	5000	
	31412	314129	portaestante	NI	-	250	2500	
	31422	314228	casquillo	NI	-	500	5000	
Blister	90348	903484	portaestante + casquillo	LT	4	-	10	
	90349	903491	portaestante + casquillo	NI	4	-	10	

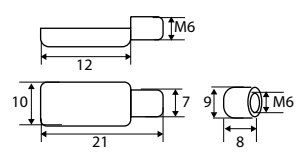

Latón  
 LATÓN NÍQUEL

### PORTAESTANTE REDONDO PE14



	Código	8431488	Medida	Acabado				€uros
Caja	31211	312118	14x4x1/8 mm	LT	-	250	2500	
	31212	312125	14x4x1/8 mm	NI	-	250	2500	
Blister	90350	903507	14x4x1/8 mm	LT	4	-	10	
	90351	903514	14x4x1/8 mm	NI	4	-	10	

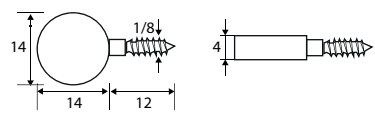

Latón  
 LATÓN NÍQUEL

### PORTAESTANTE C/GOMA PE10

	Código	8431488	Medida	Acabado				€uros
Caja	31111	311111	5 mm	LT	-	250	2500	
	31112	311128	5 mm	NI	-	250	2500	
Blister	90355	903552	5 mm	LT	4	-	10	
	90356	903569	5 mm	NI	4	-	10	

Latón

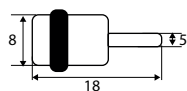

### PORTAESTANTE VENTOSA PE15

	Código	8431488	Medida	Acabado				€uros
Caja	31602	316024	5 mm	NI	-	500	2500	
Blister	90358	903583	5 mm	NI	4	-	10	

Zamak

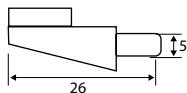

### ENGANCHE Ø20 EX5

	Código	8431488	Medida/Tablero	Acabado				€uros
Caja	30823	308234	13x8 mm/16 mm	BL	-	200	2000	

Nylon

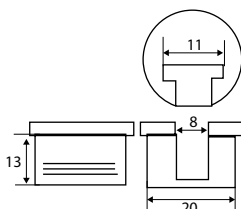

### TORNILLO ENGANCHE EX5

	Código	8431488	Medida	Acabado				€uros
Caja	30826	308265	14x6 mm	ZN	-	200	5000	
Blister	90579	905792	14x6 mm	ZN	12	-	10	

Acero

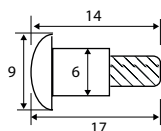

### ENGANCHE + TORNILLO EX5

	Código	8431488	Medida/Tablero	Acabado				€uros
Blister	90573	905730	13x8 mm/16 mm	BL	4	-	10	

Enganche: Nylon/Tornillo: Acero





### ENGANCHE Ø15 EX1



	Código	8431488	Medida	Acabado				€uros
Caja	<b>30838</b>	308388	10,5x7x14 mm	GR	-	100	1000	

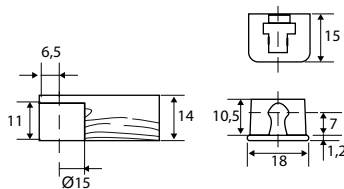

Plástico



GRIS

### PERNO ENGANCHE MADERA EX1



	Código	8431488	Medida	Acabado				€uros
Caja	<b>30839</b>	308395	11x9 mm	ZN	-	100	2500	
Blister	<b>91715</b>	917153	enganche + perno	ZN	4	-	10	

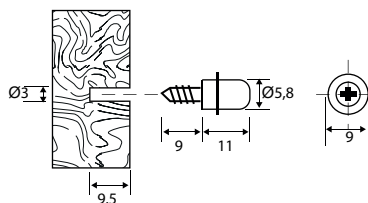

Enganche: Plástico/Perno: Acero



ZINCADO

### PERNO ENGANCHE EURO EX1



	Código	8431488	Medida	Acabado				€uros
Caja	<b>30840</b>	308401	11x8,8 mm	ZN	-	100	2500	
Blister	<b>91716</b>	917160	enganche + perno	ZN	4	-	10	

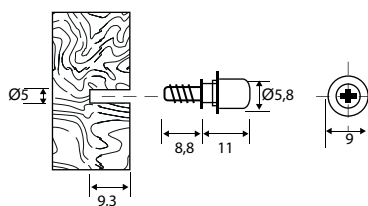

Enganche: Plástico/Perno: Acero



ZINCADO

### PERNO ENGANCHE PRESIÓN EX1



	Código	8431488	Medida	Acabado				€uros
Caja	<b>30841</b>	308418	11x12,5 mm	ZN	-	100	2500	
Blister	<b>91717</b>	917177	enganche + perno	ZN	4	-	10	

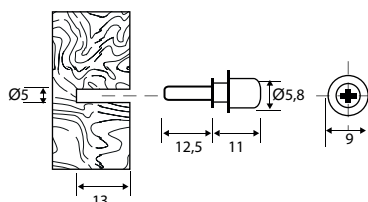

Enganche: Plástico/Perno: Acero



ZINCADO



### ENGANCHE Ø18 EX2

	Código	8431488	Medida	Acabado			€uros
Caja	<b>30842</b>	308425	13,4x16 mm	GR	-	100 1000	

Nylon

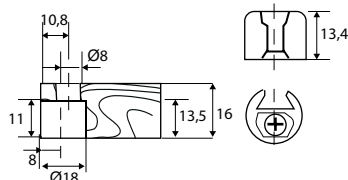

### SOPORTE ENGANCHE TACO EX2

	Código	8431488	Medida	Acabado			€uros
Caja	<b>30843</b>	308432	13,3x18 mm	NI	-	100 1000	
Blister	<b>91718</b>	917184	enganche + soporte	NI	4	- 10	

Enganche: Nylon/Soporte: Zamak

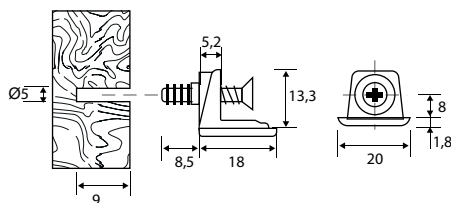

### SOPORTE ENGANCHE TORNILLO EX2

	Código	8431488	Medida	Acabado			€uros
Caja	<b>30844</b>	308449	13,3x18 mm	NI	-	100 1000	
Blister	<b>91719</b>	917191	enganche + soporte	NI	4	- 10	

Enganche: Nylon/Soporte: Zamak

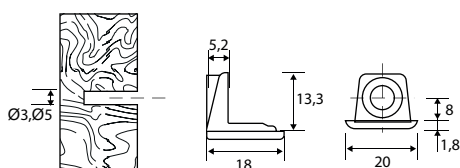



### ENGANCHE EXCÉNTRICA Ø20 EX4



	Código	8431488	Medida/Tablero	Acabado			€uros
Caja	30819	308197	13x8 mm/16 mm	NI	-	200	1000
	30822	308227	13x8 mm/16 mm	NE	-	200	1000

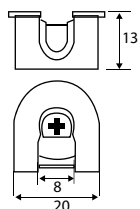

Zamak  
 NÍQUEL  
 NEGRO

### PERNO P/EXCÉNTRICA EX4



	Código	8431488	Medida/Rosca	Acabado			€uros
Caja	30832	308326	6x11 mm/madera	ZN	-	200	5000
Blistar	90572	905723	6x11 mm/madera	ZN	12	-	10

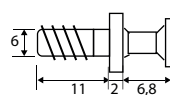

Acero  
 ZINCADO

### ENGANCHE EXCÉNTRICA Ø20 + PERNO EX4



	Código	8431488	Medida/Tablero	Acabado			€uros
Blistar	90568	905686	13x8 mm/16 mm	NI	4	-	10

Zamak  
 NÍQUEL

### ENGANCHE EX3



	Código	8431488	Medida	Acabado			€uros
Caja	30852	308524	M6x31,7x18,3 mm	NI	-	25	250

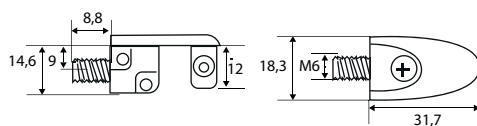

Zamak  
 NÍQUEL

### EXCÉNTRICA Ø15 EX6

	Código	8431488	Medida /Tablero	Acabado			€uros
Caja	30812	308128	12,5x8 mm/16 mm	ZN	-	200	2000
	30813	308135	14x9 mm/19 mm	ZN	-	200	2000

Zamak



ZINCADO

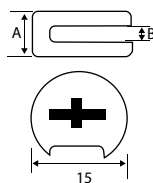

### PERNO P/EXCÉNTRICA EX6

	Código	8431488	Medida AxBxC/Rosca	Acabado			€uros
Caja	30814	308142	45x34x11 mm/madera	ZN	-	200	2000
	30815	308159	42x34x8 mm/M6	ZN	-	200	2000
Blister	90563	905631	45x34x11 mm/madera	ZN	12	-	10
	90564	905648	42x34x8 mm/M6	ZN	12	-	10

Acero



ZINCADO

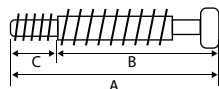

### EXCÉNTRICA + PERNO EX6

	Código	8431488	Medida/Rosca	Acabado			€uros
Blister	90561	905617	12,5x8 mm/madera	ZN	4	-	10
	90562	905624	12,5x8 mm/M6	ZN	4	-	10

Zamak



ZINCADO



### TAPÓN P/EXCÉNTRICA Ø15 EX6

	Código	8431488	Medida	Acabado			€uros
Caja	30816	308166	17 mm	BL	-	200	5000
	30817	308173	17 mm	MA	-	200	5000
	30818	308180	17 mm	NE	-	200	5000
Blister	90565	905655	17 mm	BL	12	-	10

Polietileno



BLANCO MARRÓN NEGRO

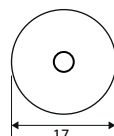



### EXCÉNTRICA Ø25 EX7

	Código	8431488	Medida/Perno	Acabado				€uros
Caja	<b>30849</b>	308494	11,7x6,5 mm	ZKN	-	100	1000	
Blíster	<b>91873</b>	918730	11,7x6,5 mm/R Madera	ZKN	4	-	10	
	<b>91874</b>	918747	11,7x6,5 mm/M6	ZKN	4	-	10	

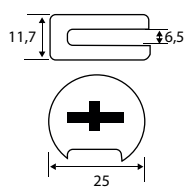

Blíster incluye perno

Zamak  
  
ZAMAK NATURAL



### EXCÉNTRICA Ø35 EX8

	Código	8431488	Medida	Acabado				€uros
Caja	<b>30853</b>	308531	16,3x9,4 mm	ZN	-	25	250	

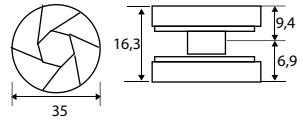

Zamak  
  
ZINCADO

### PERNO P/EXCÉNTRICA EX8

	Código	8431488	Medida	Acabado				€uros
Caja	<b>30854</b>	308548	M6x35x10 mm	ZN	-	25	625	

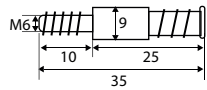

Acero  
  
ZINCADO

### TACO GRAFILADO TC1

	Código	8431488	Medida AxBxC	Acabado				€uros
Caja	<b>30836</b>	308364	M6x23x8 mm	LT	-	100	2500	
	<b>30837</b>	308371	M8x28x10 mm	LT	-	100	2500	

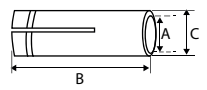

Latón  
  
LATÓN

### TUERCA EMBUTIR TRC3

	Código	8431488	Medida MxAxB	Acabado			€uros
Caja	30802	308029	1/4x10x12 mm	BC	-	100 2500	
	30828	308289	M6x12x12 mm	ZN	-	250 2500	
	30829	308296	M6x12x14 mm	ZN	-	250 2500	
	30830	308302	M8x13x16 mm	BC	-	250 1250	
	30835	308357	M10x15x17 mm	BC	-	250 1250	
Blister	90556	905563	M6x12x12 mm	ZN	4	- 10	
	90557	905570	M6x12x14 mm	ZN	4	- 10	
	90558	905587	M8x13x16 mm	BC	4	- 10	
	91378	913780	M10x15x17 mm	BC	4	- 10	

Acero

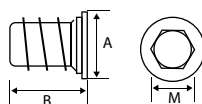

### TUERCA EMBUTIR TRC5

	Código	8431488	Medida MxAxB	Acabado			€uros
Caja	30845	308456	M6x10x13 mm	ZKN	-	100 2500	
	30848	308487	M8x12x18 mm	ZKN	-	100 1000	
Blister	91570	915708	M6x10x13 mm	ZKN	4	- 10	
	91835	918358	M8x12x18 mm	ZKN	4	- 10	

Zamak

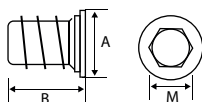

### TUERCA EMBUTIR TRC4

	Código	8431488	Medida	Acabado			€uros
Caja	30831	308319	M6x11x11 mm	BL	-	250 2500	
Blister	90559	905594	M6x11x11 mm	BL	8	- 10	

Nylon

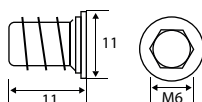

### TUERCA EXPANSIBLE TRC6

	Código	8431488	Medida	Acabado			€uros
Caja	30833	308333	M6x12x8 mm	LT	-	200 5000	
Blister	90560	905600	M6x12x8 mm	LT	4	- 10	

Latón

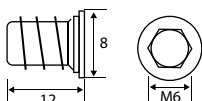



### TUERCA ÉMBOLO TRC7



	Código	8431488	Medida	Acabado				€uros
Caja	<b>30801</b>	308012	M6x10x14 mm	NI	-	250	2500	
Blister	<b>91720</b>	917207	M6x10x14 mm	NI	8	-	10	

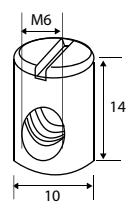

Tornillo Komby disponible en página 281

Acero  
 NIQUEL

### TUERCA PÚA EMBUTIR TRC2



	Código	8431488	Medida AxBxC	Acabado				€uros
Caja	<b>30804</b>	308043	M4x17x8	ZN	-	100	2500	
	<b>30806</b>	308067	M6x16x9,5	ZN	-	100	2500	
	<b>30808</b>	308081	M8x22x12	ZN	-	100	1000	
	<b>30810</b>	308104	M10x22x12	ZN	-	100	1000	
Blister	<b>90552</b>	905525	M4x17x8	ZN	4	-	10	
	<b>90553</b>	905532	M6x16x9,5	ZN	4	-	10	
	<b>90554</b>	905549	M8x22x12	ZN	4	-	10	
	<b>90555</b>	905556	M10x22x12	ZN	4	-	10	

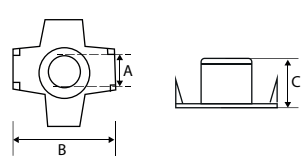

Acero  
 ZINCADO

### MEDIA LUNA MDL1

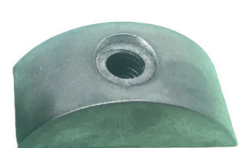

	Código	8431488	Medida	Acabado				€uros
Caja	<b>30855</b>	308555	M6x32 mm	ZKN	-	50	500	
	<b>30856</b>	308562	M8x32 mm	ZKN	-	50	500	
Blister	<b>92330</b>	923307	M6x32 mm	ZKN	4	-	10	
	<b>92331</b>	923314	M8x32 mm	ZKN	4	-	10	

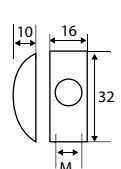

Zamak  
 ZAMAK NATURAL

### MEDIA LUNA MDL2



	Código	8431488	Medida	Acabado				€uros
Caja	<b>30857</b>	308579	6x28 mm	BL	-	100	1000	
Blister	<b>92332</b>	923321	6x28 mm	BL	4	-	10	

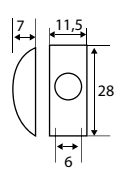

Nylon  
 BLANCO

### TORNILLO EURO TRN17

	Código	8431488	Medida	Acabado				€uros
Caja	30834	308340	6,3x7,7x10 mm	ZN	-	200	5000	
Blister	91688	916880	6,3x7,7x10 mm	ZN	12	-	10	

Acero

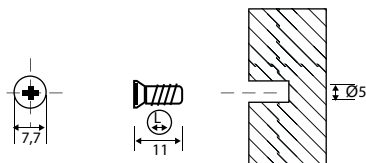

### GRAPA TRASERA RECTANGULAR GRP1

	Código	8431488	Medida	Acabado				€uros
Caja	30800	308005	23x17 mm	ZN	-	1000	3000	
Blister	90582	905822	23x17 mm	ZN	10	-	10	

Acero

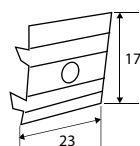

### GRAPA TRASERA REDONDA GRP2

	Código	8431488	Medida	Acabado				€uros
Caja	30799	307992	15 mm	ZN	-	200	5000	
Blister	91326	913261	15 mm	ZN	10	-	10	

Acero

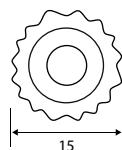

### OVALILLO ARANDELA OV3

	Código	8431488	Medida A	Acabado				€uros
Caja	30795	307954	12 mm	LTD	-	1000	10000	
	30796	307961	14 mm	LTD	-	1000	10000	
	30797	307978	12 mm	NI	-	1000	10000	
	30798	307985	14 mm	NI	-	1000	10000	
Blister	91725	917252	12 mm	LTD	25	-	10	
	91726	917269	14 mm	LTD	25	-	10	
	91723	917238	12 mm	NI	25	-	10	
	91724	917245	14 mm	NI	25	-	10	

Acero





## ÁNGULO TRASERA AN22

	Código	8431488	Medida	Acabado			€uros
Caja	<b>61000</b>	610009	19x19 mm	NI	-	100	1000
Blister	<b>91568</b>	915685	19x19 mm	NI	4	-	10

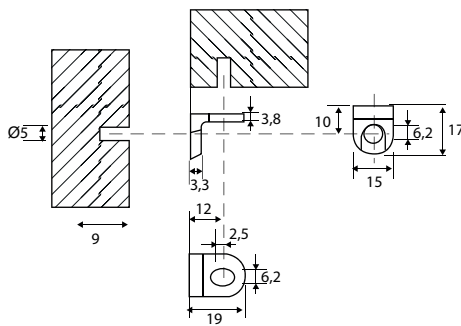

Zamak  
 NIQUEL

## ÁNGULO TRASERA C/TORNILLO AN21

	Código	8431488	Medida	Acabado			€uros
Caja	<b>61003</b>	610030	14x12 mm	NE	-	100	2500
Blister	<b>91569</b>	915692	14x12 mm	NE	4	-	10

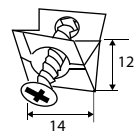

Nylon  
 NEGRO

## ÁNGULO C/TAPA AN20

	Código	8431488	Medida Ax B	Acabado			€uros
Caja	<b>61001</b>	610016	18x20 mm	BL	-	200	2000
	<b>61002</b>	610023	42x20 mm	BL	-	100	1000
	<b>61011</b>	610115	18x20 mm	BE	-	200	2000
	<b>61012</b>	610122	42x20 mm	BE	-	100	1000
	<b>61021</b>	610214	18x20 mm	MA	-	200	2000
	<b>61022</b>	610221	42x20 mm	MA	-	100	1000
Blister	<b>90450</b>	904504	18x20 mm	BL	4	-	10
	<b>90453</b>	904535	42x20 mm	BL	4	-	10
	<b>90451</b>	904511	18x20 mm	BE	4	-	10
	<b>90454</b>	904542	42x20 mm	BE	4	-	10
	<b>90452</b>	904528	18x20 mm	MA	4	-	10
	<b>90455</b>	904559	42x20 mm	MA	4	-	10



Incluye tornillos en el blister

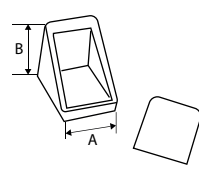

Plástico  
 BLANCO  
 BEIGE  
 MARRÓN

## TORNILLO ENSAMBLE TNE7

	Código	8431488	Medida	Acabado			€uros
Caja	<b>30500</b>	305004	78x28 mm	ZN	-	25	125

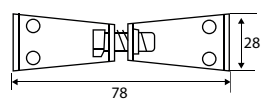
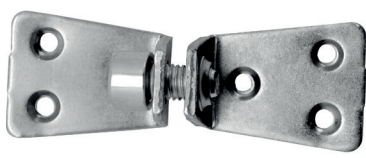

Acero  
 ZINCADO



### TORNILLO ENSAMBLE TNE6

	Código	8431488	Medida	Acabado				€uros
Caja	30502	305028	39x24 mm	BC	-	100	300	

Acero



BICROMATADO

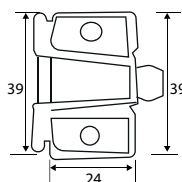

### ENGANCHE STRONG ENG2

	Código	8431488	Medida	Acabado				€uros
Caja	30506	305066	38x21 mm	BL	-	50	500	
	30507	305073	38x21 mm	MA	-	50	500	

Plástico



BLANCO



MARRÓN

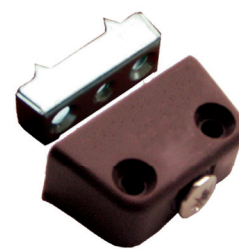
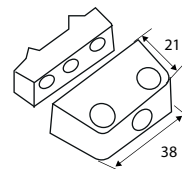

### ENGANCHE STRONG ENG3

	Código	8431488	Medida	Acabado				€uros
Caja	30508	305080	38x21 mm	ZN	-	50	500	

Zamak



ZINCADO

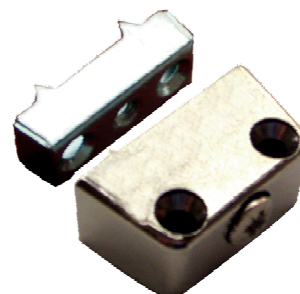
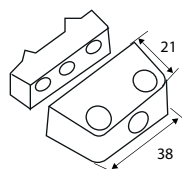

### TORNILLO ENSAMBLE TNE1

	Código	8431488	Medida Ax B	Acabado				€uros
Caja	30202	302027	5x50 mm	ZN	-	1000	3000	
	30203	302034	7x50 mm	ZN	-	500	1500	
	30212	302126	5x50 mm	NE	-	1000	3000	
	30213	302133	7x50 mm	NE	-	500	1500	
Blister	90319	903194	5x50 mm	ZN	8	-	10	
	90320	903200	7x50 mm	ZN	8	-	10	
	90500	905006	5x50 mm	NE	8	-	10	
	90743	907437	7x50 mm	NE	8	-	10	

Acero



ZINCADO



NEGRO

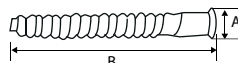

Tapón TPV5 disponible en página 262



### TUERCA ENSAMBLE TNE9

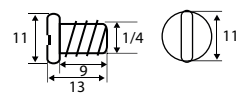

	Código	8431488	Medida	Acabado				€uros
Caja	40001	400013	13x11x1/4 mm	LT	-	100	2500	
	40002	400020	13x11x1/4 mm	NI	-	100	2500	

Latón  
 LATÓN  
 NIQUEL

### ESPÁRRAGO TNE10

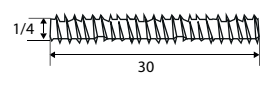
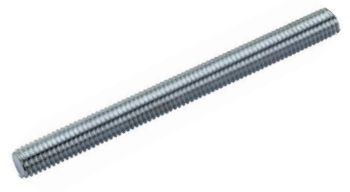

	Código	8431488	Medida	Acabado				€uros
Caja	40030	400303	1/4x30 mm	ZN	-	100	2500	

Acero  
 ZINCADO

### TUERCA ENSAMBLE TNE9 + ESPÁRRAGO TNE10



	Código	8431488	Medida	Acabado				€uros
Blister	90324	903248	1/4x30 mm	LT	4	-	10	
	90329	903293	1/4x30 mm	NI	4	-	10	

Latón/Acero  
 LATÓN  
 NIQUEL

### TORNILLO ENSAMBLE TNE8



	Código	8431488	Medida	Acabado				€uros
Caja	30312	303123	26-36 mm	BL	-	100	2000	
	30302	303024	34-44 mm	BL	-	100	500	
	30311	303116	26-36 mm	MA	-	100	2000	
	30301	303017	34-44 mm	MA	-	100	500	
Blister	90333	903330	26-36 mm	BL	4	-	10	
	90334	903347	34-44 mm	BL	4	-	10	
	90335	903354	26-36 mm	MA	4	-	10	
	90336	903361	34-44 mm	MA	4	-	10	

Acero  
 BLANCO  
 MARRÓN

### TORNILLO UNIÓN TNE11



	Código	8431488	Medida	Acabado				€uros
Caja	32624	326245	27 mm	NI	-	500	5000	
	32626	326269	31 mm	NI	-	500	5000	

Acero  
 NIQUEL

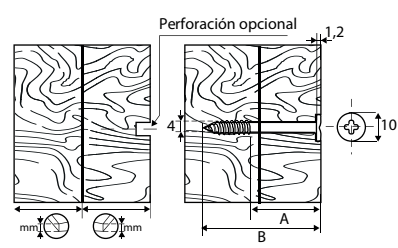

	A	B	mm
32624	16	27	15-16
32626	20	31	18-20

### JGO TORNILLO UNIÓN KOMBY M4 TNE5

	Código	8431488	Medida	Acabado				€uros
Caja	<b>32623</b>	326238	M4x15x27 mm	NI	-	100	1000	
Blister	<b>91728</b>	917283	M4x15x27 mm	NI	4	-	10	

Acero

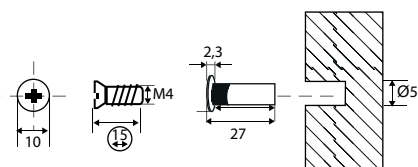

### JGO TORNILLO UNIÓN KOMBY M6 TNE4

	Código	8431488	Medida	Acabado				€uros
Caja	<b>00100</b>	001005	M6x14x33 mm	LTD	-	100	500	
	<b>00101</b>	001012	M6x14x33 mm	NI	-	100	500	
Blister	<b>90321</b>	903217	M6x14x33 mm	LTD	4	-	10	
	<b>90322</b>	903224	M6x14x33 mm	NI	4	-	10	

Acero



### TUBO UNIÓN KOMBY M6 TNE2

	Código	8431488	Medida	Acabado				€uros
Caja	<b>31625</b>	316253	8x29 mm	LTD	-	500	1500	
	<b>32625</b>	326252	8x29 mm	NI	-	500	1500	

Acero

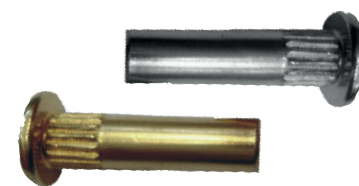

### TORNILLO KOMBY M6 TNE3

	Código	8431488	Medida AxB	Acabado				€uros
Caja	<b>31615</b>	316154	M6x15 mm	LTD	-	500	2500	
	<b>32615</b>	326153	M6x15 mm	NI	-	500	2500	
	<b>32616</b>	326160	M6x20 mm	NI	-	250	1250	
	<b>32617</b>	326177	M6x25 mm	NI	-	250	1250	
	<b>32618</b>	326184	M6x30 mm	NI	-	250	1250	
	<b>32619</b>	326191	M6x35 mm	NI	-	250	1250	
	<b>32620</b>	326207	M6x40 mm	NI	-	250	1250	
	<b>32621</b>	326214	M6x50 mm	NI	-	250	1250	
Blister	<b>90593</b>	905938	M6x15 mm	NI	12	-	10	
	<b>90594</b>	905945	M6x20 mm	NI	12	-	10	
	<b>90595</b>	905952	M6x25 mm	NI	10	-	10	
	<b>90596</b>	905969	M6x30 mm	NI	10	-	10	
	<b>90597</b>	905976	M6x35 mm	NI	10	-	10	
	<b>90598</b>	905983	M6x40 mm	NI	8	-	10	
	<b>90599</b>	905990	M6x50 mm	NI	8	-	10	
	<b>90600</b>	906003	M6x60 mm	NI	6	-	10	

Acero

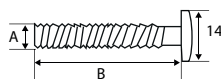



## TORNILLO CASCABEL TRN15

	Código	843 I 488	Medida Ax B	Acabado				€uros
Caja	00438	004389	9x40 mm	BC	-	25	250	
	00439	004396	9x60 mm	BC	-	25	250	
	00440	004402	9x80 mm	BC	-	25	250	
	00441	004419	9x100 mm	BC	-	25	250	
	00476	004761	9x120 mm	BC	-	25	1250	
	00477	004778	9x140 mm	BC	-	25	1250	
Blister	92110	921105	9x40 mm	BC	2	-	10	
	92111	921112	9x60 mm	BC	2	-	10	
	92112	921129	9x80 mm	BC	2	-	10	
	92113	921136	9x100 mm	BC	2	-	10	

Incluye tuerca y arandela

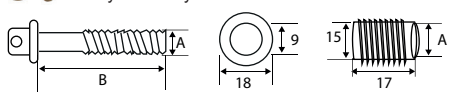

Acero  
BICROMATADO

## TORNILLO ANCLAJE TRN6

	Código	843 I 488	Medida	Acabado				€uros
Caja	44830	448305	M6x30 mm	BC	-	1000	3000	
Blister	90206	902067	M6x30 mm	BC	10	-	10	

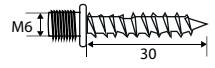

Acero  
BICROMATADO

## TORNILLO DOWELL TRN9

	Código	843 I 488	Medida Ax B	Acabado				€uros
Caja	00420	004204	M4x20 mm	ZN	-	1000	10000	
	00421	004211	M4x30 mm	ZN	-	500	5000	
	00422	004228	M6x40 mm	ZN	-	100	1000	
	00423	004235	M6x60 mm	ZN	-	100	1000	
	00670	006703	M6x70 mm	ZN	-	100	1000	
	00425	004259	M8x60 mm	ZN	-	100	1000	
	00426	004266	M8x70 mm	ZN	-	100	1000	
	00427	004273	M8x80 mm	ZN	-	100	500	
	00428	004280	M8x100 mm	ZN	-	100	500	
	00429	004297	M10x50 mm	ZN	-	50	500	
	00430	004303	M10x60 mm	ZN	-	50	500	
	00431	004310	M10x90 mm	ZN	-	50	500	
	00432	004327	M10x100 mm	ZN	-	50	250	
Blister	90207	902074	M4x20 mm	ZN	8	-	10	
	91989	919898	M4x30 mm	ZN	8	-	10	
	91990	919904	M6x40 mm	ZN	4	-	10	
	91991	919911	M6x60 mm	ZN	4	-	10	
	90208	902081	M6x70 mm	ZN	4	-	10	
	91993	919935	M8x60 mm	ZN	2	-	10	
	91994	919942	M8x70 mm	ZN	2	-	10	
	91995	919959	M8x80 mm	ZN	2	-	10	
	91996	919966	M8x100 mm	ZN	2	-	10	
	91997	919973	M10x50 mm	ZN	2	-	10	
91998	919980	M10x60 mm	ZN	2	-	10		
91999	919997	M10x90 mm	ZN	2	-	10		
92100	921006	M10x100 mm	ZN	2	-	10		

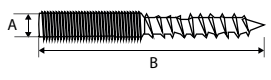

Acero  
ZINCADO

### ESPÁRRAGO ROSCA MADERA TRN13

	Código	8431488	Medida AxB	Acabado				€uros
Caja	00433	004334	8x60 mm	ZN	-	100	1000	
	00434	004341	8x70 mm	ZN	-	100	1000	
	00435	004358	8x75 mm	ZN	-	100	500	
Blister	92118	921181	8x60 mm	ZN	2	-	10	
	92119	921198	8x70 mm	ZN	2	-	10	
	92120	921204	8x75 mm	ZN	2	-	10	

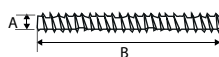

### ESPÁRRAGO 2 ROSCAS TRN14

	Código	8431488	Medida	Acabado				€uros
Caja	00436	004365	4x40 mm	ZN	-	100	2500	
Blister	92101	921013	4x40 mm	ZN	4	-	10	

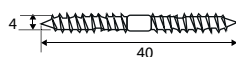

### TORNILLO SILLA TRN10

	Código	8431488	Medida AxB	Acabado				€uros
Caja	43158	431581	3/16x15 mm	NI	-	100	2500	
	43159	431598	3/16x20 mm	NI	-	100	2500	
	43160	431604	3/16x25 mm	NI	-	100	2500	
	43161	431611	3/16x30 mm	NI	-	100	2500	
	43162	431628	3/16x35 mm	NI	-	100	2500	
	43163	431635	3/16x40 mm	NI	-	100	2500	
	43164	431642	3/16x45 mm	NI	-	100	2500	
	43165	431659	3/16x50 mm	NI	-	100	1000	
	43166	431666	3/16x60 mm	NI	-	50	1250	
	43167	431673	3/16x70 mm	NI	-	50	1250	



No incluye tuerca

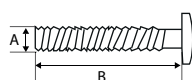

### TUERCA SILLA TRC8

	Código	8431488	Medida	Acabado				€uros
Caja	30316	30316	3/16	NI	-	100	2500	

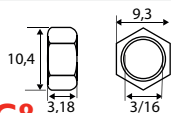

### TORNILLO TRN10 + TUERCA SILLA TRC8

	Código	8431488	Medida AxB	Acabado				€uros
Blister	92153	921532	3/16x15 mm	NI	4	-	10	
	92154	921549	3/16x20 mm	NI	4	-	10	
	92155	921556	3/16x25 mm	NI	4	-	10	
	92156	921563	3/16x30 mm	NI	4	-	10	
	92157	921570	3/16x35 mm	NI	4	-	10	
	92158	921587	3/16x40 mm	NI	4	-	10	
	92159	921594	3/16x45 mm	NI	4	-	10	
	90205	902050	3/16x50 mm	NI	4	-	10	
	92160	921600	3/16x60 mm	NI	4	-	10	
	92161	921617	3/16x70 mm	NI	4	-	10	





### UNIÓN PANELES ENS3 Y ENS4

	Código	8431488	Montaje	Acabado				€uros
Caja	30515	305158	sobrepuesto	NE	-	50	500	
	30514	305141	suspendido	NE	-	50	500	

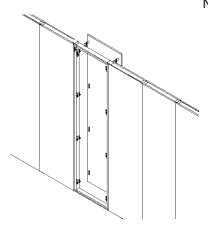
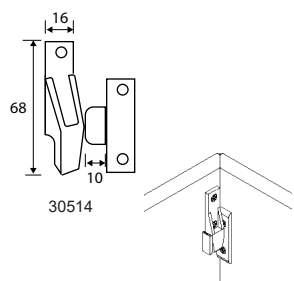
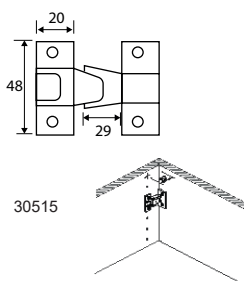

Nylon  
 NEGRO

### ENSAMBLE ENCIMERA ENS1

	Código	8431488	Medida	Acabado			€uros
Caja	30846	308463	M8x48 mm	BL	-	25	250

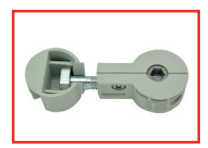
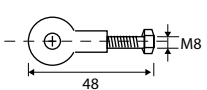

Zamak  
 BLANCO

### ENSAMBLE ENCIMERA ENS2

	Código	8431488	Medida	Acabado			€uros
Caja	30847	308470	M6x150 mm	ZN	-	25	1250

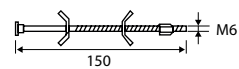
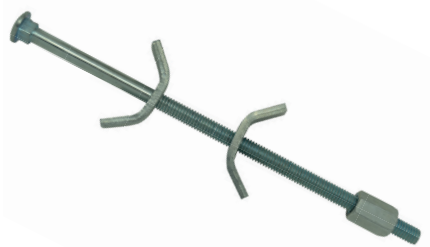

Acero  
 ZINCADO

### GALLETA MADERA ENS9

	Código	8431488	Tipo/Medida AxB	Acabado			€uros
Caja	41018	410180	nº 0 - 48x15 mm	HAYA	-	1000	-
	41019	410197	nº 10 - 55x20 mm	HAYA	-	1000	-
	41020	410203	nº 20 - 60x25 mm	HAYA	-	1000	-
Blister	91506	915067	nº 0 - 48x15 mm	HAYA	20	-	10
	91507	915074	nº 10 - 55x20 mm	HAYA	20	-	10
	90344	903446	nº 20 - 60x25 mm	HAYA	20	-	10

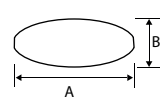

Madera  
 HAYA

### ESPIGA METÁLICA ENS8

	Código	8431488	Medida	Acabado			€uros
Caja	41021	410210	9,3x37 mm	ZN/VE	-	100	1000

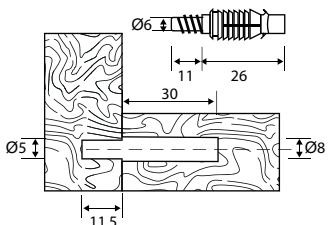

Acero/PVC  
 ZINCADO/  
 VERDE

**ESPIGA MADERA ENS5**

	Código	8431488	Medida AxB	Acabado				€uros
Caja	<b>46300</b>	463001	6x30 mm	HAYA	-	100	10000	
	<b>46350</b>	463506	6x35 mm	HAYA	-	100	10000	
	<b>46400</b>	464008	6x40 mm	HAYA	-	100	10000	
	<b>48300</b>	483009	8x30 mm	HAYA	-	100	5000	
	<b>48350</b>	483504	8x35 mm	HAYA	-	100	5000	
	<b>48400</b>	484006	8x40 mm	HAYA	-	100	5000	
	<b>41035</b>	410357	10x35 mm	HAYA	-	100	5000	
	<b>41040</b>	410401	10x40 mm	HAYA	-	100	5000	
	<b>41240</b>	412405	12x40 mm	HAYA	-	100	2500	
	<b>41440</b>	414409	14x60 mm	HAYA	-	100	2500	
Blister	<b>90341</b>	903415	6x30 mm	HAYA	25	-	10	
	<b>90342</b>	903422	8x40 mm	HAYA	25	-	10	
	<b>90343</b>	903439	10x40 mm	HAYA	20	-	10	

Haya



**VARILLA MADERA ESTRIADA ENS6**

	Código	8431488	Medida AxB	Acabado				€uros
	<b>41060</b>	410609	6x1 mt	HAYA	-	10	-	
	<b>41080</b>	410807	8x1 mt	HAYA	-	10	-	
	<b>41100</b>	411002	10x1 mt	HAYA	-	10	-	
	<b>41120</b>	411200	12x1 mt	HAYA	-	10	-	
	<b>41140</b>	411408	14x1 mt	HAYA	-	10	-	
	<b>41160</b>	411606	16x1 mt	HAYA	-	10	-	
	<b>41142</b>	411422	18x1 mt	HAYA	-	10	-	
	<b>41143</b>	411439	20x1 mt	HAYA	-	10	-	

Haya



Etiquetado individualmente

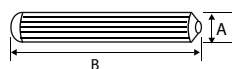

**VARILLA MADERA LISA ENS7**

	Código	8431488	Medida AxB	Acabado				€uros
	<b>41141</b>	411415	5x0,8 mts	HAYA	-	10	-	
	<b>41161</b>	411613	6x1 mt	HAYA	-	10	-	
	<b>41162</b>	411620	8x1 mt	HAYA	-	10	-	
	<b>41163</b>	411637	10x1 mt	HAYA	-	10	-	
	<b>41164</b>	411644	12x1 mt	HAYA	-	10	-	
	<b>41165</b>	411651	14x1 mt	HAYA	-	10	-	
	<b>41166</b>	411668	16x1 mt	HAYA	-	10	-	
	<b>41167</b>	411675	18x1 mt	HAYA	-	10	-	
	<b>41168</b>	411682	20x1 mt	HAYA	-	10	-	
	<b>41169</b>	411699	25x1 mt	HAYA	-	10	-	

Haya



Etiquetado individualmente

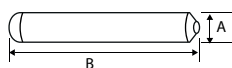



### DESILZANTE CLAVO DZ1

	Código	8431488	Medida A	Acabado				€uros
Caja	60511	605111	15 mm	BL	-	1000	10000	
	60503	605036	15 mm	BL	-	100	5000	
	60512	605128	15 mm	MA	-	1000	10000	
	60504	605043	15 mm	MA	-	100	5000	
	60521	605210	17 mm	BL	-	1000	10000	
	60505	605050	17 mm	BL	-	100	5000	
	60522	605227	17 mm	MA	-	1000	10000	
Blister	90374	903743	15 mm	BL	4	-	10	
	90375	903750	17 mm	BL	4	-	10	
	90377	903774	15 mm	MA	4	-	10	
	90378	903781	17 mm	MA	4	-	10	



Polipropileno



### DESILZANTE FIELTRO DZ2

	Código	8431488	Medida A	Acabado				€uros
Caja	60536	605364	17 mm	MA	-	500	5000	
	60537	605371	20 mm	MA	-	500	5000	
	60538	605388	25 mm	MA	-	250	2500	
	60539	605395	30 mm	MA	-	200	2000	
Blister	90588	905884	17 mm	MA	4	-	10	
	90589	905891	20 mm	MA	4	-	10	
	90590	905907	25 mm	MA	4	-	10	
	90591	905914	30 mm	MA	4	-	10	



Fieltro



### DESILZANTE METÁLICO DZ3

	Código	8431488	Medida A	Acabado				€uros
Caja	60531	605319	15 mm	NI	-	100	1000	
	60532	605326	18 mm	NI	-	100	1000	
	60533	605333	20 mm	NI	-	100	1000	
	60534	605340	23 mm	NI	-	100	500	
	60535	605357	26 mm	NI	-	100	500	
Blister	90583	905839	15 mm	NI	4	-	10	
	90584	905846	18 mm	NI	4	-	10	
	90585	905853	20 mm	NI	4	-	10	
	90586	905860	23 mm	NI	4	-	10	
	90587	905877	26 mm	NI	4	-	10	



Acero



### DESILZANTE CLAVO SD DZ4

	Código	8431488	Medida A	Acabado				€uros
Caja	60546	605463	20 mm	GR	-	50	500	
	60547	605470	25 mm	GR	-	50	500	
	60548	605487	30 mm	GR	-	50	500	
Blister	91455	914558	20 mm	GR	4	-	10	
	91456	914565	25 mm	GR	4	-	10	
	91457	914572	30 mm	GR	4	-	10	



Polietileno





**DESLIZANTE ADHESIVO SD DZ5**

	Código	8431488	Medida AxB	Acabado			€uros
Caja	60540	605401	20 mm	GR	-	50	1250
	60541	605418	25 mm	GR	-	50	1250
	60542	605425	30 mm	GR	-	50	1250
	60543	605432	24x24 mm	GR	-	50	1250
	60544	605449	30x30 mm	GR	-	50	500
	60545	605456	24x100 mm	GR	-	25	250
Blister	91408	914084	20 mm	GR	4	-	10
	91409	914091	25 mm	GR	4	-	10
	91410	914107	30 mm	GR	4	-	10
	91411	914114	24x24 mm	GR	4	-	10
	91412	914121	30x30 mm	GR	4	-	10
	91553	915531	24x100 mm	GR	4	-	10

Polietileno



GRIS

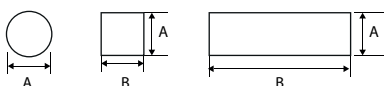

**DESLIZANTE ATORNILLAR SD DZ6**

	Código	8431488	Medida A	Acabado			€uros
Caja	60525	605258	19 mm	GR	-	50	1250
	60526	605265	25 mm	GR	-	50	500
	60527	605272	30 mm	GR	-	50	500
	60528	605289	38 mm	GR	-	25	250
Blister	92366	923666	19 mm	GR	4	-	10
	92367	923673	25 mm	GR	4	-	10
	92368	923680	30 mm	GR	4	-	10
	92369	923697	38 mm	GR	4	-	10

Polietileno



GRIS

Incluye tornillo



**DESLIZANTE ATORNILLAR GOMA DZ10**

	Código	8431488	Medida	Acabado			€uros
Caja	60523	605234	20 mm	TR	-	100	1000
	60524	605241	25 mm	TR	-	100	500
Blister	92313	923130	20 mm	TR	4	-	10
	92314	923147	25 mm	TR	4	-	10

Goma



TRANSPARENTE

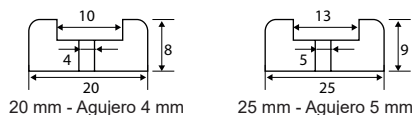

20 mm - Agujero 4 mm

25 mm - Agujero 5 mm



**CUÑA NIVELADORA NV11 / NV14**

	Código	8431488	Medida AxBxC	Acabado			€uros
Caja	43511	435114	60x30x7 mm	TR	-	100	1000
	43510	435107	100x20x8 mm	MA	-	100	1000
Blister	92312	923123	60x30x7 mm	TR	2	-	10
	90198	901985	100x20x8 mm	MA	4	-	10

43511: Poliestireno

43510: Goma

43510: Autocortable



TRANSPARENTE



MARRÓN

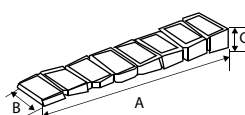

NV14 - 43511



NV11 - 43510



## FIELTRO ADHESIVO DZ7



	Código	8431488	Medida A	Acabado				€uros
Caja	60549	605494	16 mm	MA	-	1000	10000	
	60550	605500	20 mm	MA	-	1000	10000	
	60551	605517	22 mm	MA	-	800	8000	
	60552	605524	26 mm	MA	-	600	6000	
	60553	605531	28 mm	MA	-	450	4500	
	60554	605548	34 mm	MA	-	300	3000	
	60555	605555	16 mm	BL	-	1000	10000	
	60556	605562	20 mm	BL	-	1000	10000	
	60557	605579	22 mm	BL	-	800	8000	
	60558	605586	26 mm	BL	-	600	6000	
	60559	605593	28 mm	BL	-	450	4500	
60560	605609	34 mm	BL	-	300	3000		
Blister	91389	913896	16 mm	MA	20	-	10	
	91395	913957	20 mm	MA	15	-	10	
	91390	913902	22 mm	MA	15	-	10	
	91391	913919	26 mm	MA	6	-	10	
	91554	915548	28 mm	MA	6	-	10	
	91392	913926	34 mm	MA	4	-	10	
	91396	913964	16 mm	BL	20	-	10	
	91402	914022	20 mm	BL	15	-	10	
	91397	913971	22 mm	BL	15	-	10	
	91398	913988	26 mm	BL	6	-	10	
	91559	915593	28 mm	BL	6	-	10	
	91399	913995	34 mm	BL	4	-	10	

Espesor 3 mm



Fieltro  
 BLANCO  
 MARRÓN

## FIELTRO ADHESIVO DZ9 (ROLLO)



	Código	8431488	Medida AxB	Acabado				€uros
Caja	60575	605753	85x1 mt	MA	-	5	50	
	60576	605760	85x1 mt	BL	-	5	50	
Blister	92171	921716	85x1 mt	MA	1	-	10	
	92172	921723	85x1 mt	BL	1	-	10	

Espesor 3 mm



Fieltro  
 MARRÓN  
 BLANCO

**FIELTRO ADHESIVO DZ8**

	Código	8431488	Medida AxB	Acabado			€uros
Caja	60561	605616	17x17 mm	MA	-	1000	10000
	60562	605623	22x22 mm	MA	-	800	8000
	60563	605630	25x25 mm	MA	-	600	6000
	60564	605647	30x30 mm	MA	-	450	4500
	60565	605654	100x100 mm	MA	-	50	500
	60566	605661	50x100 mm	MA	-	100	1000
	60573	605739	85x100 mm	MA	-	50	500
	60567	605678	17x17 mm	BL	-	1000	10000
	60568	605685	22x22 mm	BL	-	800	8000
	60569	605692	25x25 mm	BL	-	600	6000
	60570	605708	30x30 mm	BL	-	450	4500
	60571	605715	100x100 mm	BL	-	50	500
	60572	605722	50x100 mm	BL	-	100	1000
	60574	605746	85x100 mm	BL	-	50	500
Blister	91393	913933	17x17 mm	MA	20	-	10
	91394	913940	22x22 mm	MA	12	-	10
	91555	915555	25x25 mm	MA	6	-	10
	91556	915562	30x30 mm	MA	6	-	10
	91558	915586	50x100 mm	MA	2	-	10
	91557	915579	85x100 mm	MA	1	-	10
	91400	914008	17x17 mm	BL	20	-	10
	91401	914015	22x22 mm	BL	12	-	10
	91560	915609	25x25 mm	BL	6	-	10
	91561	915616	30x30 mm	BL	6	-	10
	91563	915630	50x100 mm	BL	2	-	10
	91562	915623	85x100 mm	BL	1	-	10



Fieltro

Espesor 3 mm



**PIVOTE CENTRADOR MESA ESM3**

	Código	8431488	Medida AxB	Acabado			€uros
Caja	30516	305165	8x18 mm	LTD	-	100	2500
	30517	305172	10x22 mm	LTD	-	100	1000



Acero

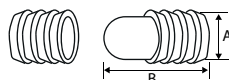

LATONADO

**ESCUADRA MESA ESM1**

	Código	8431488	Medida	Acabado			€uros
Caja	30521	305219	60x34x34 mm	ZN	-	4	40

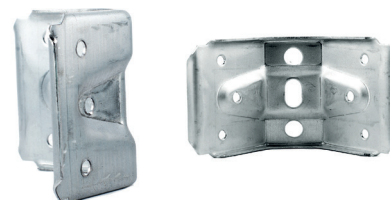

Acero

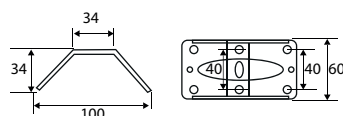

ZINCADO

**ESCUADRA MESA ESM2**

	Código	8431488	Medida	Acabado			€uros
Caja	30522	305226	60x38x60 mm	ZN	-	4	40

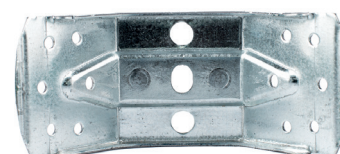

Acero

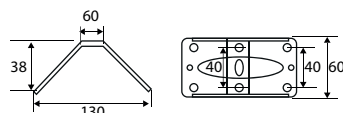

ZINCADO



## CIERRE CAJA CC1



	Código	8431488	Medida	Acabado			€uros
Caja	30511	305110	75x23 mm	ZN	-	50	250
	30527	305271	100x34 mm	ZN	-	10	100
	30525	305257	131x43 mm	ZN	-	5	25
Blister	90291	902913	75x23 mm	ZN	1	-	10
	91975	919751	100x34 mm	ZN	1	-	10
	91973	919737	131x43 mm	ZN	1	-	10

Incluye tornillos en el blister

Acero

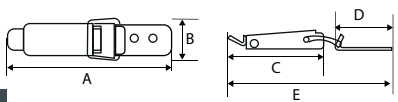

código	A	B	C	D	E	tensión máx.
30511	75 mm	23 mm	60 mm	30 mm	102 mm	130 Kgs
30527	100 mm	34 mm	86 mm	43 mm	140,5 mm	300 Kgs
30525	131 mm	43 mm	111,5 mm	66 mm	193,5 mm	400 Kgs

## CIERRE CAJA CANDADO CC1



	Código	8431488	Medida	Acabado			€uros
Caja	30510	305103	75x23 mm	ZN	-	50	250
	30528	305288	100x34 mm	ZN	-	10	100
	30526	305264	131x43 mm	ZN	-	5	25
Blister	90289	902890	75x23 mm	ZN	1	-	10
	91976	919768	100x34 mm	ZN	1	-	10
	91974	919744	131x43 mm	ZN	1	-	10

Incluye tornillos en el blister

Acero

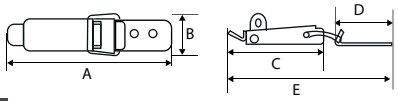

código	A	B	C	D	E	tensión máx.
30510	75 mm	23 mm	60 mm	30 mm	102 mm	130 Kgs
30528	100 mm	34 mm	86 mm	43 mm	140,5 mm	300 Kgs
30526	131 mm	43 mm	111,5 mm	66 mm	193,5 mm	400 Kgs

## CIERRE CAJA CC2



	Código	8431488	Medida	Acabado			€uros
Caja	30529	305295	42x23 mm	ZN	-	25	250
Blister	91977	919775	42x23 mm	ZN	1	-	10

Incluye tornillos en el blister

Tensión máxima 150 Kgs

Acero

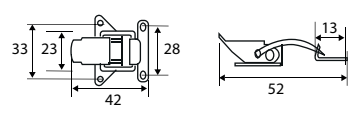

## CIERRE CAJA CANDADO CC2



	Código	8431488	Medida	Acabado			€uros
Caja	30530	305301	42x23 mm	ZN	-	25	250
Blister	91978	919782	42x23 mm	ZN	1	-	10

Incluye tornillos en el blister

Tensión máxima 150 Kgs

Acero

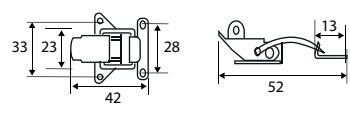

### CIERRE CAJA CC3

	Código	8431488	Medida	Acabado				€uros
Caja	<b>30512</b>	305127	53x23 mm	ZN	-	50	250	
Blister	<b>90290</b>	902906	53x23 mm	ZN	1	-	10	

Acero  
  
ZINCADO

Incluye tornillos en el blister  
▲ Tensión máxima 100 Kgs

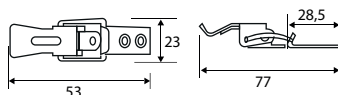

### CIERRE CAJA CC4

	Código	8431488	Medida	Acabado				€uros
Caja	<b>30531</b>	305318	50x22 mm	ZN	-	25	250	
Blister	<b>91979</b>	919799	50x22 mm	ZN	1	-	10	

Acero  
  
ZINCADO

Incluye tornillos en el blister  
▲ Tensión máxima 100 Kgs

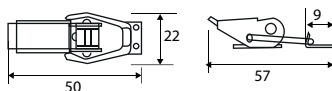

### CIERRE CAJA CC5

	Código	8431488	Medida	Acabado				€uros
Caja	<b>30532</b>	305325	70x28 mm	ZN	-	25	125	
Blister	<b>91980</b>	919805	70x28 mm	ZN	1	-	10	

Acero  
  
ZINCADO

Incluye tornillos en el blister  
▲ Tensión máxima 250 Kgs

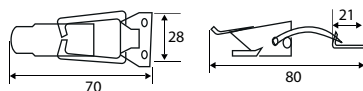

### CIERRE CAJA REGULABLE CC6

	Código	8431488	Medida	Acabado				€uros
Caja	<b>30533</b>	305332	138-150 mm	ZN	-	5	50	
Blister	<b>91981</b>	919812	138-150 mm	ZN	1	-	10	

Acero  
  
ZINCADO

Incluye tornillos en el blister  
▲ Tensión máxima 250 Kgs

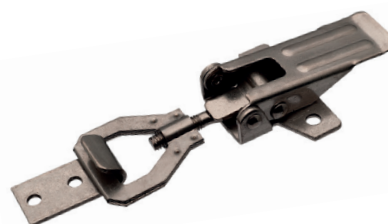
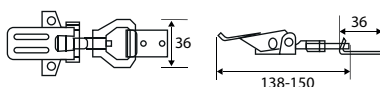

### CIERRE CAJA C/LLAVE CC7

	Código	8431488	Medida	Acabado				€uros
Caja	<b>30534</b>	305349	131x43 mm	NE	-	5	25	
Blister	<b>92164</b>	921648	131x43 mm	NE	1	-	10	

Acero  
  
NEGRO

Incluye tornillos en el blister  
▲ Tensión máxima 400 Kgs

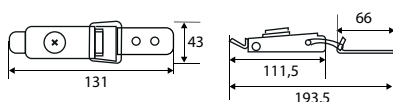



## TORNILLO CAMA TRN12



	Código	8431488	Medida AxB	Acabado				€uros
Caja	00442	004426	9x60 mm	BC	-	25	250	
	00443	004433	9x80 mm	BC	-	25	250	
	00444	004440	9x100 mm	BC	-	25	250	
	00475	004754	9x140 mm	BC	-	25	125	
Blister	92114	921143	9x60 mm	BC	2	-	10	
	92115	921150	9x80 mm	BC	2	-	10	
	92116	921167	9x100 mm	BC	2	-	10	

Incluye tuerca y arandela

Acero

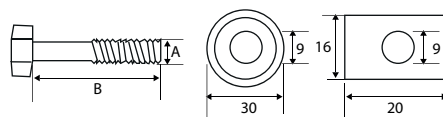

## TUERCA RECTANGULAR TRC10



	Código	8431488	Medida	Acabado				€uros
Caja	00445	004457	9x16 mm	BC	-	25	250	
Blister	92117	921174	9x16 mm	BC	6	-	10	

Acero

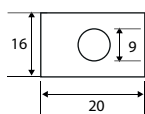

## ENGANCHE LARGUERO CAMA SMR4



	Código	8431488	Medida	Acabado				€uros
Caja	96423	964232	80 mm	ZN	-	4	40	

Acero

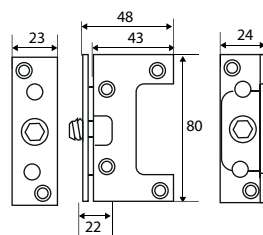

## JGO ENGANCHE CAMA SMR3

	Código	8431488	Medida	Acabado				€uros
Caja	96415	964157	95x23 mm	ZN	-	10	30	

1 juego = 8 piezas

Acero

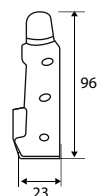

### SOPORTE SOMIER SMR1

	Código	8431488	Medida	Acabado			€uros
Caja	96414	964140	55x50 mm	ZN	-	50	250

Acero

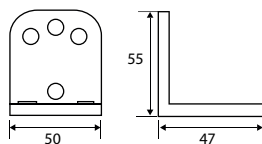

### SOPORTE LARGUERO CAMA SMR2

	Código	8431488	Medida A	Acabado			€uros
Caja	96420	964201	40 mm	ZN	-	8	80
	96421	964218	50 mm	ZN	-	8	80

Acero

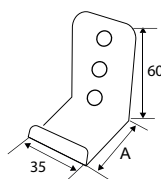

### ESCUADRA BAÑERA CAMA SMR5

	Código	8431488	Medida	Acabado			€uros
Caja	96419	964195	310x76 mm	GV	-	4	32

Acero

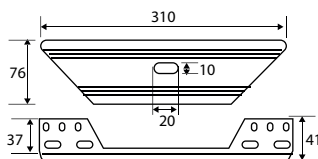

### SOPORTE ESCALERA LITERA SMR6

	Código	8431488	Medida	Acabado			€uros
Caja	96422	964225	71x20 mm	ZN	-	10	250

Acero

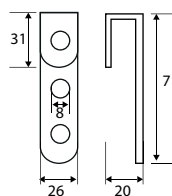



### VARILLA HUECA P/LÁMPARAS VR1

	Código	843 I 488	Medida A	Acabado				€uros
Caja	40061	400617	M10/100x20 mm	ZN	-	100	1000	
	40062	400624	M10/100x40 mm	ZN	-	100	1000	
	40063	400631	M10/100x100 mm	ZN	-	50	250	
	40064	400648	M10/100x1 mt	ZN	-	5	-	

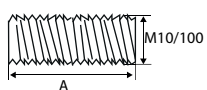

Acero  
 ZINCADO

### TUERCA P/VARILLA HUECA TRC9

	Código	843 I 488	Medida Ax B	Acabado				€uros
Caja	40065	400655	M10/100x13x4 mm	ZN	-	100	2500	
Blister	91986	919867	M10/100x13x4 mm	ZN	4	-	10	

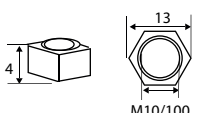

Acero  
 ZINCADO

### VARILLA HUECA VR1 + TUERCA TRC9

	Código	843 I 488	Medida Ax B	Acabado				€uros
Blister	91983	919836	M10/100x20 mm	ZN	2	-	10	
	91984	919843	M10/100x40 mm	ZN	2	-	10	
	91985	919850	M10/100x100 mm	ZN	2	-	10	



Acero  
 ZINCADO

### TUERCA CIEGA TRC1

	Código	843 I 488	Medida MxAxB	Acabado				€uros
Caja	49041	490410	M4x7x6,5 mm	LT	-	250	6250	
	49042	490427	M4x7x6,5 mm	NI	-	250	6250	
	49051	490519	M5x8x7 mm	LT	-	250	6250	
	49052	490526	M5x8x7 mm	NI	-	250	6250	
	49061	490618	M6x10x8 mm	LT	-	250	6250	
	49062	490625	M6x10x8 mm	NI	-	250	6250	
	49081	490816	M8x12x10 mm	LT	-	250	2500	
	49082	490823	M8x12x10 mm	NI	-	250	2500	
	49101	491011	M10x13x12 mm	LT	-	250	2500	
	49102	491028	M10x13x12 mm	NI	-	250	2500	
Blister	90220	902203	M4x7x6,5 mm	LT	10	-	10	
	90221	902210	M4x7x6,5 mm	NI	10	-	10	
	90222	902227	M5x8x7 mm	LT	10	-	10	
	90223	902234	M5x8x7 mm	NI	10	-	10	
	90224	902241	M6x10x8 mm	LT	10	-	10	
	90225	902258	M6x10x8 mm	NI	10	-	10	
	90228	902289	M8x12x10 mm	LT	8	-	10	
	90229	902296	M8x12x10 mm	NI	8	-	10	
	90230	902302	M10x13x12 mm	LT	8	-	10	
	90231	902319	M10x13x12 mm	NI	8	-	10	

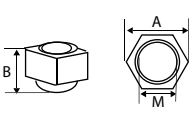

Latón  
 NIQUEL LATÓN